



RADEON™ X700 PCIe Series

User's Guide

P/N 137-40742-10

RADEON X700

Copyright © 2004, ATI Technologies Inc. All rights reserved.

ATI and ATI product and product feature names are trademarks and/or registered trademarks of ATI Technologies Inc. All other company and/or product names are trademarks and/or registered trademarks of their respective owners. Features, performance and specifications are subject to change without notice. Product may not be exactly as shown in diagrams.

Reproduction of this manual, or parts thereof, in any form, without the express written permission of ATI Technologies Inc. is strictly prohibited.

Disclaimer

While every precaution has been taken in the preparation of this document, ATI Technologies Inc. assumes no liability with respect to the operation or use of ATI hardware, software or other products and documentation described herein, for any act or omission of ATI concerning such products or this documentation, for any interruption of service, loss or interruption of business, loss of anticipatory profits, or for punitive, incidental or consequential damages in connection with the furnishing, performance, or use of the ATI hardware, software, or other products and documentation provided herein.

ATI Technologies Inc. reserves the right to make changes without further notice to a product or system described herein to improve reliability, function or design. With respect to ATI products which this document relates, ATI disclaims all express or implied warranties regarding such products, including but not limited to, the implied warranties of merchantability, fitness for a particular purpose, and non-infringement.

Product Notices

Dolby® Laboratories, Inc.

Manufactured under license from Dolby Laboratories. Confidential Unpublished Works.
© 1992-1997 Dolby Laboratories, Inc. All rights reserved.

Macrovision

Apparatus Claims of U.S. Patent Nos. 4,631,603, 4,577,216, 4,819,098, and 4,907,093 licensed for limited viewing uses only.

This product incorporates copyright protection technology that is protected by method claims of certain U.S. patents and other intellectual property rights owned by Macrovision Corporation and other rights owners. Use of this copyright protection technology must be authorized by Macrovision Corporation, and is intended for home and other limited viewing uses only unless otherwise authorized by Macrovision Corporation. Reverse engineering or disassembly is prohibited.



IMPORTANT SAFETY INSTRUCTIONS

- **Read Instructions** - All the safety and operating instructions should be read before the product is operated.
- **Retain Instructions** - The safety and operating instructions should be retained for future reference.
- **Heed Warnings** - All warnings on the product and the operating instructions should be adhered to.
- **Compatibility** - This option card is for use only with IBM AT or compatible UL Listed personal computers that have Installation Instructions detailing user installation of card cage accessories.
- **Grounding** - For continued protection against risk of electric shock and fire, this accessory should be installed only in products equipped with a three-wire grounding plug, a plug having a third (grounding) pin. This plug will only fit into a grounding-type power outlet. This is a safety feature. If you are unable to insert the plug into the outlet, contact your electrician to replace the obsolete outlet. Do not defeat the safety purpose of the grounding-type plug.
- **Secure Attachment** - All card securement pins shall be completely tightened as to provide continuous bonding between the option card and the PC chassis.
- **Outdoor Antenna Grounding** - Since an outdoor antenna or cable system is connected to the product, be sure that the antenna or cable system is grounded so as to provide some protection against voltage surges and built-up static charges. Article 810 of the National Electrical Code, ANSI/NFPA 70, provides information with regard to proper grounding of the mast and supporting structure, grounding of the lead-in wire to the antenna discharge unit, size of grounding conductors, location of antenna-discharge unit, connection of grounding electrodes, and requirements for the grounding electrode.
- **Lightning** - For added protection for this product during a lightning storm, or when it is left unattended and unused for long periods of time, unplug it from the wall outlet, and disconnect the antenna or cable system. This will prevent damage to the product due to lightning and power-line surges.
- **Power Lines** - An outside antenna system should not be located in the vicinity of overhead power lines or other light or power circuits, or where it can fall into such power lines or circuits.
- **Antenna Installation** - When installing an outside antenna system, extreme care should be taken to keep from touching such power lines or circuits, as contact with them may be fatal.
- **Note to CATV System Installer** - This reminder is provided to call the CATV systems installer's attention to Section 820-40 of the NEC, which provides guidelines for proper grounding and, in particular, specifies that the cable ground shall be connected to the grounding system of the building, as close to the point of cable entry as practical.

Table of Contents

Introduction	1
<i>System Requirements</i>	1
<i>External Connections</i>	1
Using Multiple Displays	3
<i>Connecting Your Monitors</i>	3
Display Configurations	5
ATI's CATALYST™ Software Suite	7
Introduction	7
Features	7
<i>Multiple Displays and 3D Gaming</i>	7
<i>HYDRAVISION™</i>	7
<i>Accessing the CATALYST™ Software Suite</i>	7
ATI Displays Tab	8
<i>Dynamic Display Reassignment</i>	10
ATI Color Tab	11
Color Hotkeys Settings	14
ATI Options Tab	17
ATI Rotation Tab	18
Rotation HotKeys	20
ATI Overlay Tab	21
<i>Video Overlay</i>	21
<i>Clone Mode Settings</i>	22
<i>ATI 3D Tab</i>	24
<i>Custom Properties Dialog</i>	26
Direct 3D® Compatibility Settings	29
<i>OpenGL® Compatibility Settings</i>	30
<i>ATI VPU Recover Tab</i>	31
Using TV Display and Capture Features	33
Using TV Out	33
<i>Viewing Your PC's Display on a TV</i>	33
<i>Connecting to a TV</i>	33
<i>Starting Windows® with TV Display Enabled</i>	35
<i>Using and Adjusting TV Display Features</i>	35
<i>TV Display Hardware Restrictions</i>	35
<i>Using a Monitor vs. Using TV Display</i>	35

<i>Adjusting Monitor Display</i>	36
<i>Viewing Text on a TV</i>	36
<i>Reducing Edge Distortion</i>	36
<i>Using TV Display Alone</i>	37
<i>Using Games and Applications</i>	37
Connecting to HDTV	38
<i>Using Your ATI HDTV Video Cable</i>	39
Capturing Video	40
<i>Connecting your media device for video capture</i>	41
<i>Setting the Windows® Volume Control</i>	42
Troubleshooting	43
Uninstalling Old Graphics Card Software	43
Windows® New Hardware Found	43
Installing the CATALYST™ Software Suite	44
Solution Selector	45
Compliance Information	49
<i>FCC Compliance Information</i>	49
<i>Industry Canada Compliance Statement</i>	49
<i>CE Compliance Information</i>	50
<i>L'Information de conformité de la CE</i>	50
<i>CE-Konformitätserklärung</i>	50
Index	51

CHAPTER 1:

Introduction

System Requirements

Hardware	<ul style="list-style-type: none">• Intel® Pentium® 4.• 128 MB of system memory; 256 MB or more for best performance.• Motherboard with free PCI Express slot and correct PCIe chipset-driver.• CD-ROM drive (for installation software).
Operating System	<ul style="list-style-type: none">• Windows® XP (Home or Pro).• Windows® 2000
Monitor	<ul style="list-style-type: none">• High-resolution MultiSync or multi-frequency monitors or any other type of VGA monitor.• Digital flat-panel (DFP) displays or digital CRT display.

External Connections

- 15-pin D-shell (female) VGA output.
- DVI-I output.
- S-Video output or Video In/Video Out (VIVO) connection.

CHAPTER 2:

Using Multiple Displays

Connecting Your Monitors

Your RADEON™ X700 PCIe Series provides hardware support for one DVI-I monitor or two VGA monitors using the supplied DVI-I-to-VGA adapter. It also provides TV output via a S-Video Out or Composite Out connector.

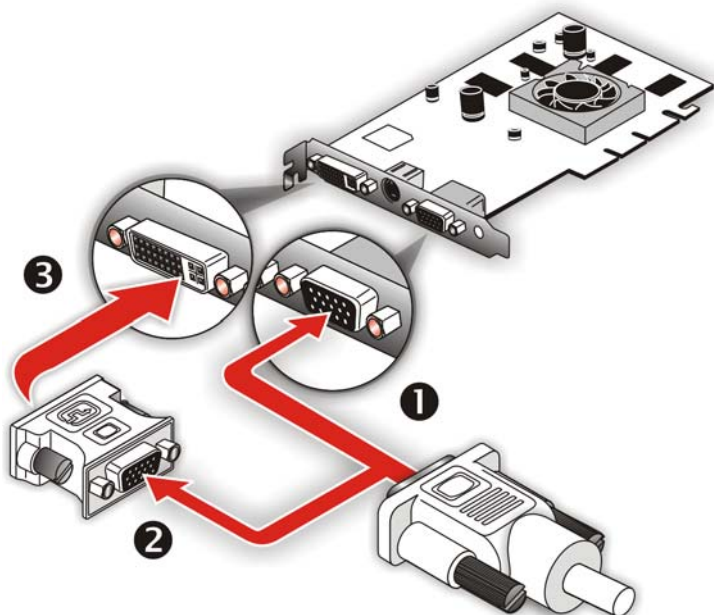

Connections and Adapters for the RADEON™ X700 PCIe Series Card

- 1 Standard VGA Monitor Connector.** To connect a VGA monitor to the DVI-I connector, plug the supplied DVI-I-to-VGA adapter into the DVI-I connector, then plug your monitor cable into the adapter.
- 2 DVI-I-to-VGA Adapter.**

Connections and Adapters for the RADEON™ X700 PCIe Series Card

- 3 DVI-I Backplate Connection.** To connect a flat panel, plug the monitor's DVI-I connector into the DVI-I connection.
-

Note: If you use multiple monitors, the RADEON™ X700 PCIe Series card must be the primary graphics card. Normally, the system BIOS determines which graphics card will be the primary.

To connect your monitors

- 1 Power off** your computer and monitors.
- 2 Plug** the monitor cables into their appropriate connectors.
- 3 Power on** your monitors first, and then restart your computer so that Windows® can detect the new hardware settings.
- 4** When the **New Hardware Found** Wizard appears, at the appropriate prompt insert the ATI Installation CD to load the drivers for your RADEON™ X700 PCIe Series card.

To set up a multi-monitor display

- From the **Start menu** click **Control Panel**, then **Display**. Click the **Settings** tab to access the basic multi-monitor configuration settings.

Note: ATI software provides many additional configuration features that can be accessed by clicking the **Advanced** button from the **Display Properties > Settings** tab.

- Select the **Monitor** icon identified by the number **2**.
- Click **Extend my Windows desktop onto this monitor**.
- Set the **Screen Resolution** and **Color Quality** as appropriate for the second monitor. Click **Apply** or **OK** to apply these new values.
 - Refer to your Windows® online help and documentation for further information on using the **Settings** tab.

Note: When you use multiple monitors with your card, one monitor will always be **Primary**. Any additional monitors will be designated as **Secondary**.

Display Configurations

Your RADEON™ X700 PCIe Series graphics card provides dual display functionality and TV Out. The following table lists the different ways you can connect displays to your card.

Display Configuration	Connector(s) Used	Comments
Single CRT display	VGA connector OR DVI-I connector with DVI-I-to-VGA adapter	CRT- cathode ray tube analog display.
Single DFP display	DVI-I connector	DFP - digital flat panel display.
Single TV	S-Video Out	The S-Video out can also support a composite connection via the S-Video-to-Composite adapter.
Single HDTV display	S-Video Out to HDTV (YPrPb) cable	HDTV - High Definition Television
CRT display + TV	VGA connector + S-Video Out	UNSUPPORTED CONFIGURATION if the CRT display is attached to the DVI-I connector via the DVI-I-to-VGA adapter.
CRT display + HDTV	VGA connector + S-Video Out to HDTV (YPrPb) cable	
DFP display + TV	DVI-I connector + S-Video out	
DFP display + HDTV	DVI-I connector + S-Video Out to HDTV (YPrPb) cable	
CRT display + DFP display	VGA connector + DVI-I connector	
CRT display + CRT display	VGA connector + DVI-I connector with DVI-I-to-VGA adapter	The DVI-I connector can support a CRT display using the DVI-I-to-VGA adapter

Display Configuration	Connector(s) Used	Comments
CRT display + DFP display + TV	VGA connector + DVI-I connector + S-Video Out	The TV display will “clone” the image of one of the other two displays
CRT display + DFP display + HDTV	VGA connector + DVI-I connector + S-Video Out to HDTV (YPrPb) cable	
CRT display + CRT display + TV	VGA connector + DVI-I connector with DVI-I-to-VGA adapter + S-Video Out	UNSUPPORTED CONFIGURATION
CRT display + CRT display + HDTV	VGA connector + DVI-I connector with DVI-I-to-VGA adapter + S-Video Out to HDTV (YPrPb) cable	UNSUPPORTED CONFIGURATION

CHAPTER 3:

ATI's CATALYST™ Software Suite

Introduction

This chapter describes using the advanced multiple-monitor and 3D graphics features in ATI's CATALYST™ Software Suite.

Features

Multiple Displays and 3D Gaming

ATI's SMARTSHADER™ Software Suite provides multiple-display functionality, and its advanced graphic features, such as SMARTSHADER™, provide the ultimate 3D gaming experience.

The CATALYST™ Software Suite also supports the latest versions of Direct 3D® and OpenGL®. Many 3D game titles will virtually come to life through the advanced Direct 3D® or OpenGL® features. Gamers can fine-tune these settings for the ultimate experience in 3D image quality or 3D gaming performance.

HYDRAVISION™

In addition to the multiple display functionality available with ATI's CATALYST™ Software Suite, you can also use HYDRAVISION™ for advanced multi-monitor management. For more information on HYDRAVISION™, please refer to the **HYDRAVISION™ User's Guide** PDF located on your ATI Installation CD.

Accessing the CATALYST™ Software Suite

The CATALYST™ Software Suite installs the ATI display tabs into the Windows® **Display Properties** dialog. They are accessed through the **Advanced** button located on the **Settings** tab.

To access the **Display Properties** dialog, right-click on the desktop or navigate through Windows® **Control Panel**, which is located in the **Start** menu.

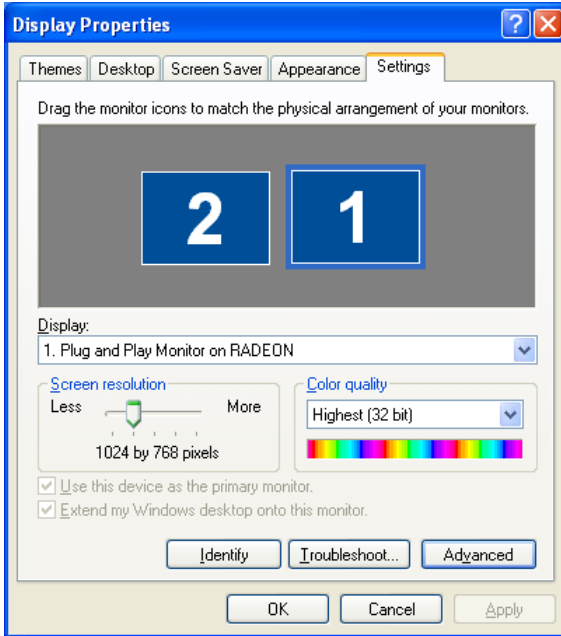

Windows® Display Properties Settings Tab

ATI Displays Tab

The ATI Displays tab provides control over multiple-monitor features. Here you can enable/disable display devices and swap the assignment of **Primary** and **Secondary** displays.

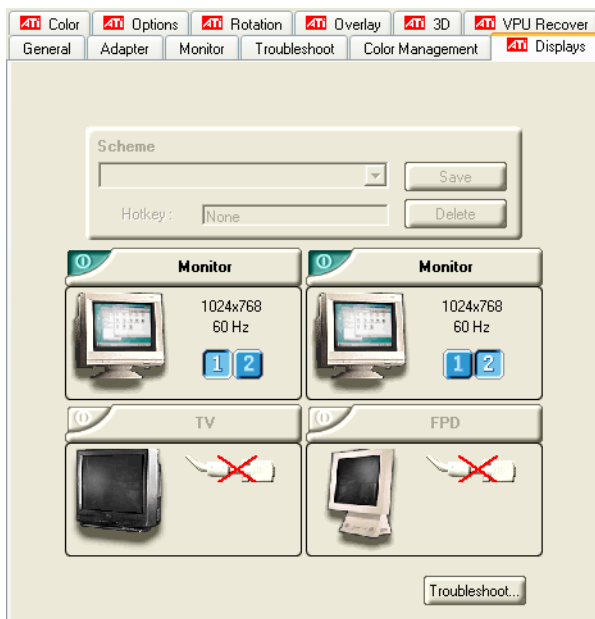

ATI Displays Tab

Scheme	Displays the drop-down list of available display-device configurations that have previously been created. New configurations can be entered here and then saved using the Save button.
Hotkey	Associates a hotkey with a scheme. To input the hotkey, highlight the field and press the appropriate key combination on your keyboard.
Save button	Saves display-device configuration schemes.
Delete button	Deletes display-device configuration schemes.
Display buttons	Enables or disables a display device; they also indicate whether a device is enabled or disabled.
Troubleshoot button	Opens a Troubleshoot dialog to assist with possible display problems.

To enable or disable a display

If the enable/disable button is green, it indicates the device is enabled. If it is red, it indicates the device is disabled. If the button is greyed out, the device is not an option. For example, if there is only one monitor connected, all buttons will be grey.

- 1 Click the enable/disable button  for the display device you want to enable/disable.
- 2 Click **OK** or **Apply** to save the changes.

Note: Due to power restrictions, you can normally only have two devices active at the same time; for example, two monitors or a monitor and a TV.

To save a display-device scheme

Display-device selections can be saved as a scheme for quick recall.

- 1 Click the enable/disable button  for the display devices you want to have active.
- 2 Type a name into the **Scheme** drop-down list field.
- 3 Click **Save** to save the scheme.



Dynamic Display Reassignment

You can change the assignment of your Primary and Secondary display on the fly, without rebooting.





Note: Before you can change the assignment of the Primary display, at least one Secondary display and the Extended Desktop mode must be enabled. Extended Desktop mode is enabled through the Windows® **Display Property** dialog, under **Settings**. For more information, consult your Windows® documentation.

To assign your Primary monitor

- 1 Click the buttons to assign the Primary monitor:
For Windows® XP

- The ATI Displays tab shows you the display(s) that are active. The Primary display has the  button depressed. To change the display assignment, click the Primary display's  button or click the  button of the other display device.

For Windows® 2000

- Clicking the  button will reassign the Primary and Secondary monitors. Clicking the  button creates a clone or mirror image of the Primary display onto the Secondary display. Clicking the  button extends your desktop to a Secondary display located to the right of the Primary display. Clicking the  button extends your desktop to a Secondary display located below the Primary display.

- 2 Click **OK** or **Apply** to save the changes.

ATI Color Tab

The ATI Color tab allows you to configure Gamma, Brightness, and Contrast color settings for both your desktop and full screen 3D environments. You can also save settings to a color profile for easy recall. In addition, you can assign unique hotkey combinations that allow you to adjust Gamma, Brightness, and Contrast color settings within your full screen 3D applications.

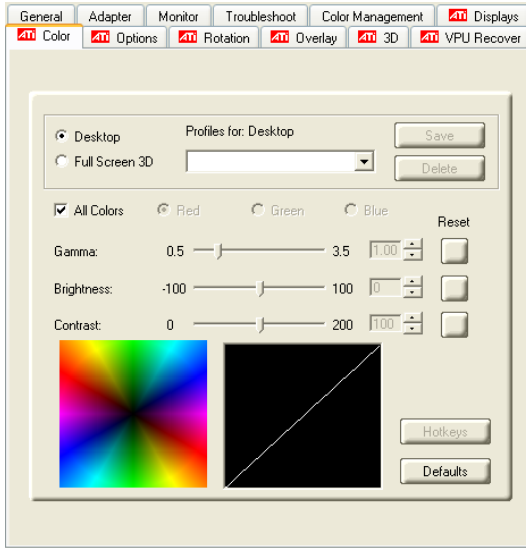

ATI Color Tab: Desktop Settings

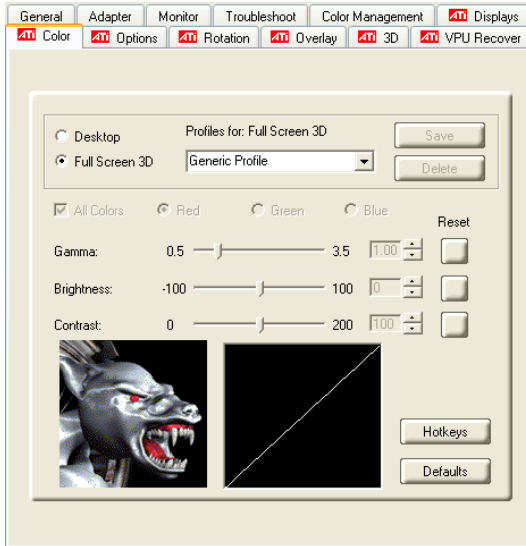

ATI Color Tab: Full Screen 3D Settings

ATI Color Tab	
Desktop radio button	Select Desktop to configure your desktop color settings.
Full Screen 3D radio button	Select Full Screen 3D to configure the color settings for your 3D application. Note that the configured settings will only be apparent within a full screen 3D application environment.
Profiles for	Indicates whether the profiles in the drop-down list are for your Desktop or a Full Screen 3D environment.
Profiles drop-down list	Lists all of the Desktop or Full Screen 3D profiles that you have saved. Selecting a profile from the list loads those custom color settings for the relevant environment. To create a new profile, simply type in a name and click Save .
Save button	Saves your current color settings to a Desktop or Full Screen 3D profile, using the name you specified in the list box. To restore these settings later, simply select the Profile name from the list and click Apply or OK .
Delete button	Deletes the profile that is selected in the Profiles list box.
All Colors checkbox	Adjusts the Gamma, Brightness or Contrast for Red, Green, and Blue simultaneously. Note that any individual color settings in effect are lost if All Colors is selected; the color settings revert back to the last-known All Colors settings.
Red, Green, and Blue radio buttons	Selects the active color component (Red, Green, or Blue) whose values will be adjusted by the Gamma, Brightness, and Contrast sliders. Note that any individual color settings made are lost if you subsequently select All Colors .
Gamma slider	Increases or decreases the gamma correction of your Desktop or full screen 3D application. Changing the gamma alters the curvature of the color curve.
Brightness slider	Increases or decreases the color brightness of your Desktop or full screen 3D application. Changing the brightness adjusts the vertical position of the color curve.
Contrast slide	Increases or decreases the color contrast of your Desktop or full screen 3D application. Changing the contrast adjusts the slope of the color curve.
Reset buttons	Restores an individual slider setting to its default value. Click Apply or OK to save.

ATI Color Tab	
Color preview box	The color image indicates visually how the Gamma, Brightness and Contrast sliders affect the final color settings of your display device. In Desktop mode, clicking on this with your mouse pointer will change the image.
Hotkeys button	Opens the Color Hotkeys Settings dialog. There you can assign hotkeys for adjusting your color settings within a full screen 3D application environment. To activate this button, you must select the Full Screen 3D radio button.
Defaults button	Restores all of the color settings to the default values. Click Apply or OK to save.

To create a Desktop or Full Screen 3D profile

- 1 Choose either the **Desktop** or **Full Screen 3D** radio button, as desired.
- 2 Adjust the **Gamma**, **Brightness**, and **Contrast** sliders to the desired settings, either individually or using the **All Colors** checkbox.
- 3 Type a profile name in the Profile list box.
- 4 Click **Save**.

Color Hotkeys Settings

Some full screen 3D applications automatically load their own color settings rather than those set through the ATI Color tab. If you want to force the application to use your custom settings, you can preconfigure hotkey combinations to either adjust the individual color properties or apply profiles you have created from within the 3D application. This control is accomplished through the Color Hotkeys Settings dialog of the Color properties tab.

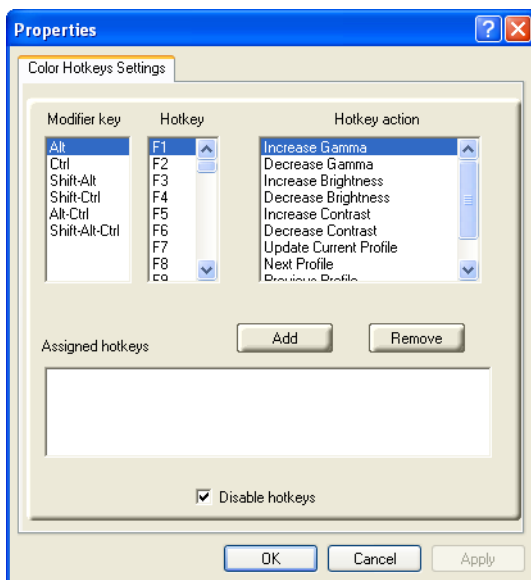

Color Hotkeys Settings Dialog

Color Hotkey Settings

Modifier key	In combination with the Hotkey , specifies the hotkey combination that triggers an action. The Modifier key can be any combination of Alt, Ctrl, or Shift. Note that the Shift key is never used alone.
Hotkey	In combination with the Modifier key , specifies the hotkey combination that triggers an action. Hotkey can be any key listed. To avoid conflicts, be aware of any hotkeys or keyboard controls that may already be assigned to your applications and 3D games.
Hotkey action	Specifies the action that the assigned hotkey combinations will control within a full screen 3D application environment. You can only assign one hotkey combination to each action.
Assigned hotkeys	Lists the assigned hotkey combinations and the actions that each one controls.
Add button	Adds a hotkey combination to the assigned list.
Remove button	Removes a hotkey combination from the assigned list.

Color Hotkey Settings

Disable hotkeys checkbox

Disables all hotkeys. To disable a single hotkey combination, remove it from the assigned list.

To assign color settings hotkeys for full screen 3D applications

- 1 Select a modifier key from the **Modifier Key** list.
- 2 Select a hotkey from the **Hotkey** list.
- 3 Select the action you want from the **Hotkey Action** list.
- 4 Click **Add** to create the hotkey combination. This combination will appear in the Assigned Hotkeys text box. Only one hotkey combination can be assigned to each action; if you assign a new combination for an action, it will overwrite an existing one.

Note: When assigning hotkeys, be careful that the key combinations you choose do not conflict with those of other applications in which you might want to use them. The ATI Color properties page only checks for duplications within the Color page itself, insofar as it allows a hotkey combination to be assigned only once.

To remove assigned hotkeys

- 1 Select a hotkey combination from the Assigned Hotkey text box.
- 2 Click **Remove**.

Note: Assigning a new combination to an action with an existing combination will overwrite the existing one.

To disable hotkeys (so that you do not accidentally activate them, for example), click the **Disable Hotkeys** checkbox. If you plan to use hotkeys, make sure this box is unchecked.

The easiest way to apply your own color settings from within a full screen 3D application is to create a Full Screen 3D profile and save it, assign hotkeys for the “Load Current Profile” action through the Hotkeys dialog, make sure that the profile you prefer is selected from the drop-down list box, and click **OK**. Once inside the 3D application, use the hotkeys to trigger the profile.

ATI Options Tab

The ATI Options tab provides detailed driver information and access to your graphics card's versioning and specifications. You can also enable or disable the ATI taskbar icon from this dialog.

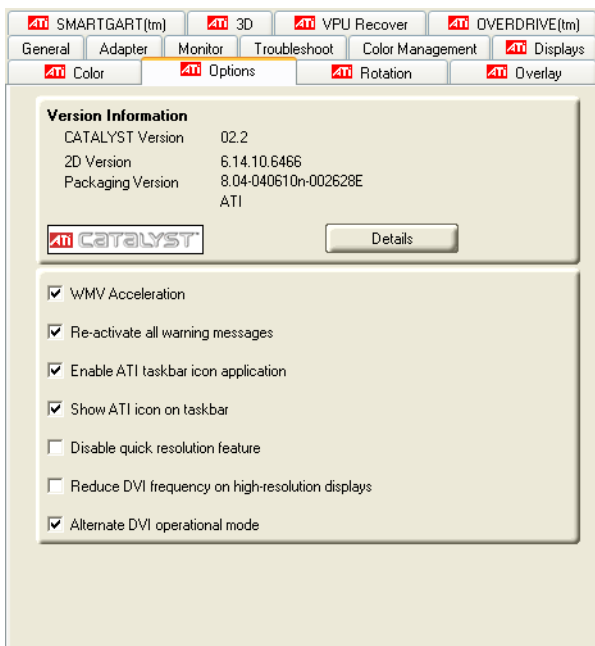

ATI Options Tab

ATI Options Tab	
Version Information	Shows the Catalyst version number, 2D version number, and the driver build information.
Details button	Gives access to the Details tab, which lists the card's hardware details and driver information.
WMV Acceleration	Enables hardware acceleration for Windows® Media Video (WMV) files.
Reactivate all warning messages	Reactivates any disabled graphics warning messages.

ATI Options Tab	
Enable ATI taskbar icon application	Enables/disables the ATI taskbar applications and removes the ATI icon from your system tray.
Show ATI icon on taskbar	Removes/replaces the ATI icon from the system tray without disabling the ATI icon applications.
Disable quick resolution feature	The quick resolution feature is accessible by left-clicking the ATI icon in the system tray. Checking this option disables this feature.
Reduce DVI frequency on high-resolution	Resolves display corruption or no image at high resolutions (for example 1280x1024 @75Hz) using a digital DVI display. This setting has no effect when using a DVI-I-to-VGA adapter.
Alternate DVI operational mode	Use this option if you are experiencing display corruption on your DVI flat panel.

ATI Rotation Tab

Use the Rotation tab to rotate the image on your display up to 180 degrees. This feature is useful when using a flat panel display that can be physically rotated to different positions.

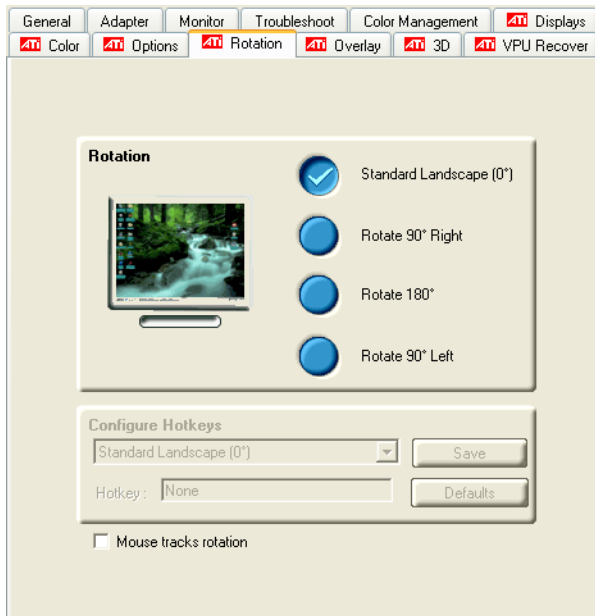

ATI Rotation Tab

ATI Rotation Tab	
Rotation buttons	Rotates the display by the preset amount.
Configure Hotkeys drop-down list	Lists the rotation actions with which you can associate a hotkey.
Hotkey field	Associates a hotkey with a rotation. To input the hotkey, click on the field and press the appropriate key combination on your keyboard.
Save button	Saves a hotkey setting.
Defaults	Restores the default hotkey settings.
Mouse tracks rotation checkbox	When selected, rotates the mouse pointer to match the display image settings. When deselected, the mouse pointer will move relative to the Standard Landscape view regardless of display rotation.

To rotate a single display

- 1 Select one of the four rotation settings by clicking the appropriate button.
- 2 Optionally, check the **Mouse Track Rotation** checkbox to have the mouse pointer match the display image.
- 3 Click **OK** or **Apply**.

To rotate multiple displays

- 1 Select the **Settings** tab in the Windows® **Display Properties** dialog.
- 2 Select the display to which you want to apply the rotation.
- 3 Click the **Advanced** button and select the **Rotation** tab.
- 4 Select one of the four rotation settings by clicking the appropriate button.
- 5 Optionally, check the **Mouse Track Rotation** checkbox to have the mouse pointer match the display image.
- 6 Click **OK** or **Apply**.

Rotation HotKeys

Hotkeys can be assigned to quickly rotate the image on your display without having to access the Windows® Display Properties dialog.

To assign rotation hotkeys

- 1 Choose the required rotation setting from the **Configure HotKeys** drop-down list.
- 2 Click on the **HotKey** field and press the appropriate key combination on your keyboard.
- 3 Click **Save**.

Note: When assigning hotkeys, be careful that the key combinations you choose do not conflict with those of other applications in which you might want to use them. The ATI Rotation page only checks for duplications within the Rotation page itself, insofar as it allows a hotkey combination to be assigned only once.

ATI Overlay Tab

The ATI Overlay tab allows you to configure the brightness, contrast, saturation, hue, and gamma properties of your video overlay.

Video Overlay

Video overlay allows for the viewing of streaming video on your PC. However, there is only one video overlay, which is only available on the **Primary** display. The video overlay controls are automatically activated during playback of any video file type that supports overlay adjustments.

Move the sliders to the right to increase the values of the various options, and to the left to decrease them.

Click the **Defaults** button to reset the values to their default settings.

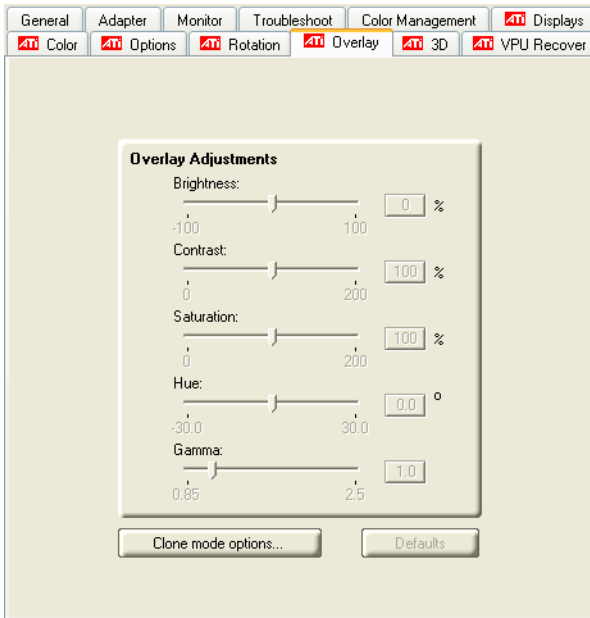

ATI Overlay Tab

ATI Overlay Tab

Brightness

Adjusts the brightness of the video image.

ATI Overlay Tab	
Contrast	Adjusts the contrast in the video image.
Saturation	Adjusts the vividness of the color. Sliding it all the way to the left removes all color and produces a black and white picture.
Hue	Adjusts the pureness or tint of the red, green, and blue components of the color.
Gamma	Adjusts the overall intensity of the video image.
Clone mode options	Accesses Clone Mode overlay settings. These settings only apply to video content when viewed in dual-controller Clone mode. For more information, see the Clone Mode Settings section.
Defaults button	Resets the Overlay settings to default values.
Theater Mode	Displays video playback in full screen on a secondary monitor, if available and enabled.

Clone Mode Settings

Clone Mode Options are available under the following conditions:

- Your ATI graphics accelerator has dual controllers to support Primary and Secondary (Clone) displays.
- Your ATI video adapter has dual display functionality by providing a standard VGA connector and a digital flat panel connector such as the DVI-I connector or to a TV using the TV-Out connector.

In either of these cases, you can access Clone Mode Options if more than one display is connected.

Note: These settings apply to video content viewed when you are in dual-controller Clone mode, and not single-display or extended desktop configurations.

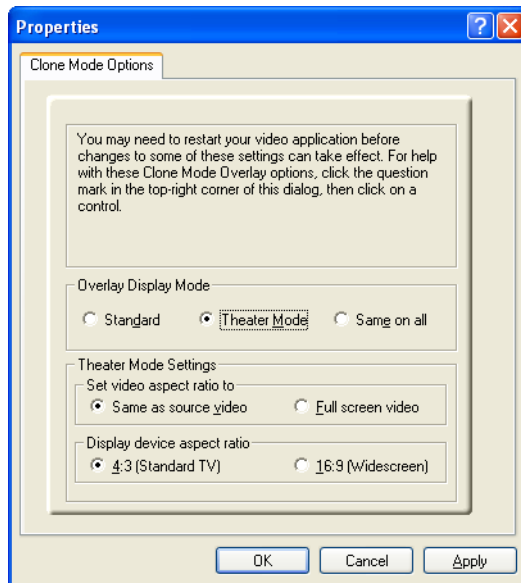

Clone Mode Options tab

Clone Mode Options	
Standard	Video content is displayed on your Primary display <i>only</i> .
Theater Mode	Video content is displayed on your Primary and Secondary displays. Video content is displayed on your Secondary display(s) is always in full screen mode. Note: your computer must be set for 16-bit color depth or higher to use this mode.
Same on all	Video content is displayed on your Primary and Secondary display in exactly the same manner. For example, all displays will show video output in full screen mode.
Theater Mode Settings	These settings are available when Theater Mode is selected.
Same as source video	The aspect ratio of the source video is maintained for full screen display. Note: that this option may result in black bars on either the horizontal or vertical sides of the video display.

Clone Mode Options

Full Screen Video	The source video is scaled so that your display is showing full screen. Note: if the source video contains horizontal black bars, as do some DVD movies, the full screen video will also contain black bars.
4:3 (Standard TV)	Select this option if the aspect ratio of the display device showing full screen video has the standard 4:3 aspect ratio (standard TVs and monitors).
16:9 (Widescreen)	Select this option if the aspect ratio of the display device is showing full screen video has a 16:9 aspect ratio (widescreen HDTVs).

ATI 3D Tab

This tab allows you to fine-tune settings for both Direct 3D® and OpenGL® applications. It displays existing settings and allows you to create unique application profiles.

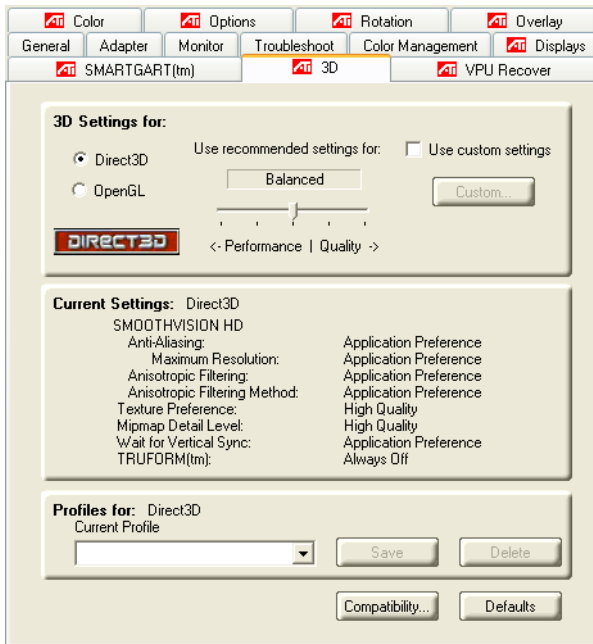

ATI 3D Tab

ATI 3D Tab	
3D Settings for radio buttons	Selects either Direct 3D® or OpenGL® as the format to be altered in the workspace.
Performance/Quality slider	Controls the overall performance/image quality of your graphic application. Moving the slider to the left will maximize application performance, while moving the slider to the right will maximize image quality.
Use Custom Settings checkbox	When Use Custom Settings is checked, the Performance/Quality slider is disabled and the Custom button is enabled. Using custom settings is recommended for advanced users only.
Custom button	Opens the Custom Properties dialog. Using custom settings is recommended for advanced users only. For more information, refer to the Custom Properties Dialog section.
Current Settings	Shows the current settings for either Direct 3D® or OpenGL®, whichever is selected.
Profiles for	Allows you to save a unique profile of the custom settings you have selected. Once you have completed making your custom settings, click OK in the Custom Properties dialog. Enter a name in Current Profile and click the Save button. Saved profiles are selected from the Current Profile drop-down window. To delete a profile, select it from the Current Profile drop-down window and press the Delete button.
Compatibility Settings button	Accesses advanced settings that may solve compatibility issues for a few specific Direct 3D® or OpenGL® applications, whichever is selected. For more information, refer to the Compatibility Dialog section.
Defaults	Resets to the dialog's default values.

Custom Properties Dialog

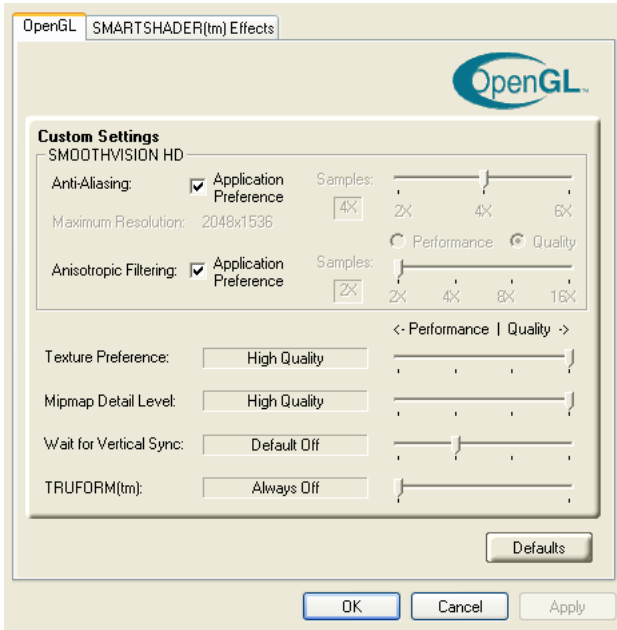

Custom Properties Dialog

Custom Properties Dialog: OpenGL® or Direct 3D®

SMOOTHVISION™ Anti-Aliasing slider

SMOOTHVISION™ (Anti-Aliasing) improves image quality by removing jagged edges from 3D images, resulting in smoother, more natural-looking objects. Anti-Aliasing can be applied using different sample patterns and sample points such as 2X or 4X. Moving this slider to the right increases sampling to provide the most realistic 3D image.

Select the **Application Preference** checkbox for high-quality images, with a negligible reduction in the application's performance.

Deselect the **Application Preference** checkbox to customize the anti-aliasing.

Custom Properties Dialog: OpenGL® or Direct 3D®

<p>SMOOTHVISION™ Anisotropic Filtering slider</p>	<p>Anisotropic filtering uses a texture filtering technique that blends multiple texture samples together. The number of samples taken when anisotropic filtering is performed can vary. By moving this slider to the right, as the number of samples taken increases, the quality of the final image increases significantly. 16X provides extremely detailed, crisp-looking images as a result of the largest number of texture samples possible.</p> <p>Selecting the Application Preference checkbox will result in high-quality images, with a negligible reduction in the application's performance.</p> <p>Select the Application Preference checkbox for high-quality images, with a negligible reduction in the application's performance.</p> <p>Deselect the Application Preference checkbox to customize the anisotropic filtering.</p>
<p>Texture Preference slider</p>	<p>Choose between high quality or high performance textures for your application. Moving the slider to the right delivers the highest quality experience. Moving the slider to the left emphasizes a high-performance solution while still providing good visuals.</p>
<p>Mipmap Detail Level slider</p>	<p>Choose the texture quality of the mipmaps the application will use. Mipmaps are a collection of different sized textures of the same image. As the user moves closer to a 3D object the image quality should increase, requiring a higher quality texture of the same image. The base mipmap is the highest quality texture, and all subsequent mipmaps are smaller sized textures of the same image. Moving the slider to the right selects a higher quality base mipmap, delivering the highest quality application experience. Moving the slider to the left selects a lower quality mipmap, delivering the highest application performance.</p>
<p>Wait for Vertical sync slider</p>	<p>Controls whether the Vertical sync is always on, always off, or controlled by the application.</p>
<p>TRUFORM™ slider</p>	<p>TRUFORM™ is a technology developed by ATI that enables higher-order surface rendering through traditional triangle rendering APIs. It improves the silhouettes and lighting of objects.</p>

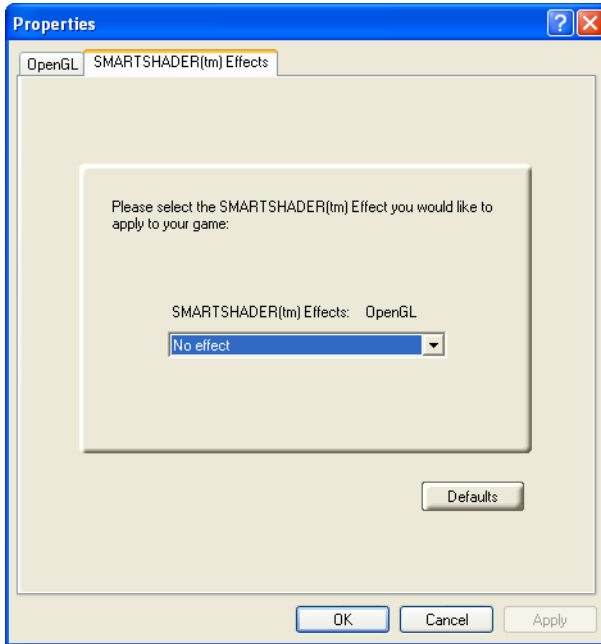

Custom Properties Dialog: SMARTSHADER™Effects

SMARTSHADER™ Effects drop-down list	SMARTSHADER™ applies preset pixel effects on OpenGL® or Direct 3D® applications. Choose the desired effect and click OK .
Defaults button	Restores the default settings.

Direct 3D® Compatibility Settings

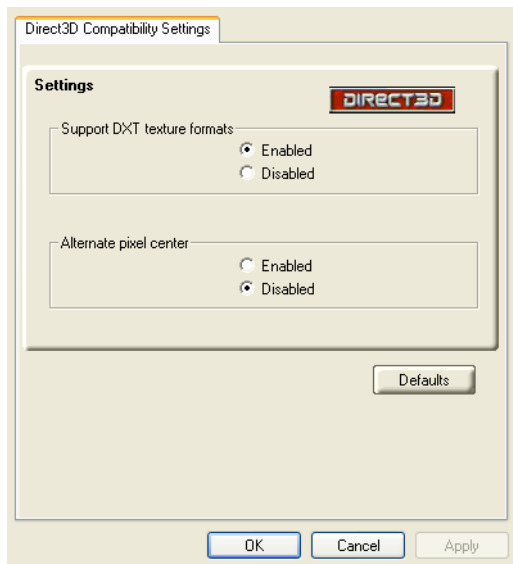

Direct 3D® Compatibility Settings Dialog

Direct 3D® Compatibility Settings	
Support DXT texture formats	There are a few applications that can only support a limited number of texture formats. By selecting Disabled, the driver will not support DXT texture formats, thus reducing the number of texture formats supported.
Alternate pixel center	May eliminate problems with some Direct 3D® games which display vertical and horizontal lines around textures, or text that appears incorrect. However, this setting should only be used if you are experiencing the symptoms mentioned, as it may cause problems with other games.
Defaults button	Resets to the dialog's default values.

OpenGL® Compatibility Settings

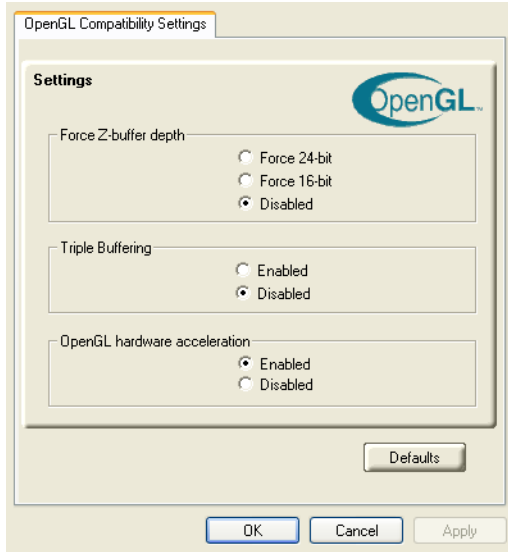

OpenGL® Compatibility Settings Dialog

OpenGL® Compatibility Settings	
Force Z-buffer depth	Explicitly set the Z-Buffer depth. Most applications will work best when Disabled is selected
Triple Buffering	Improves the frame rate of games when Wait for Vertical Sync is enabled in Custom Settings. Enabling Triple Buffering may decrease application performance as there will be less frame-buffer memory available. If there is insufficient memory available to support this feature it will be automatically disabled. It is recommended that this feature remain disabled.
Defaults button	Resets to the dialog's default values.
OpenGL® hardware acceleration	This feature should only be disabled if you are experiencing serious rendering problems. Disabling this feature will significantly decrease OpenGL® performance.

ATI VPU Recover Tab

Hardware crashes may occur when a hardware device and the corresponding software device driver are no longer able to communicate with each other. VPU Recover enables the ATI display driver to detect when the graphics card is no longer able to respond to display driver commands. When this situation arises, the display driver will reset the graphics card. Depending on the current state of the system when VPU Recover is activated, applications that are running may be able to fully recover from this reset. In other cases, running applications may be closed, and the user will be returned to the Windows® desktop.

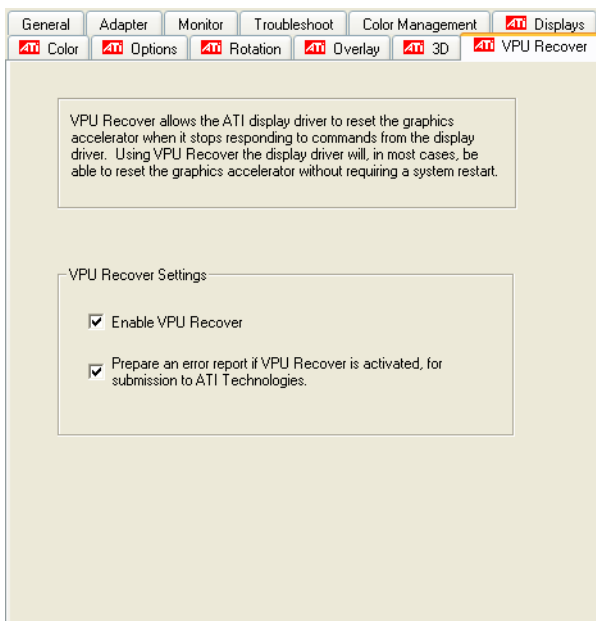

ATI VPU Recover Tab

Enable VPU Recover checkbox

Enables VPU Recover.

Prepare an Error Report checkbox

When VPU Recover is activated a dialog will prompt you to submit an automatically generated error report to ATI. This error report will help ATI to determine the cause of the problem and help create more stable drivers. To disable this feature, deselect the **Prepare an Error Report** checkbox.

CHAPTER 4:

Using TV Display and Capture Features

This chapter describes how to use the TV display and video capture features of your RADEON™ X700 PCIe Series card.

Using TV Out

Your RADEON™ X700 PCIe Series has TV Out capability.

Viewing Your PC's Display on a TV

You can attach your graphics card to a TV and monitor at the same time.



IMPORTANT INFORMATION for European Customers

Some PC monitors in Europe **cannot** be used simultaneously with TV display. When you enable TV display in Europe, the refresh rate for the monitor and TV is set to 50 Hz. Some monitors may not support this refresh rate **and could be damaged**.

- Please check the documentation supplied with your monitor to see if your monitor supports a refresh rate of 50 Hz.
- If your monitor does not support 50 Hz (or if you are not sure), turn off your monitor before turning on your PC when using your TV as a display.

TV display is ideal for giving presentations and watching movies, or playing games on a screen larger than a typical monitor. The following tips will help you get the most out of your TV Out feature.

Connecting to a TV

To connect your RADEON™ X700 PCIe Series card to a TV, use an S-Video cable.

To connect S-Video Out

- 1 Power off your computer and your TV.
- 2 Determine if your TV supports either a S-Video or Composite video connection.

- 3 Looking at the back of your PC, locate your S-Video Out. Using an S-Video cable, attach one end of the cable to your graphics card and the other to your TV. Refer to the illustration.
- 4 Power on your TV first, then your computer.

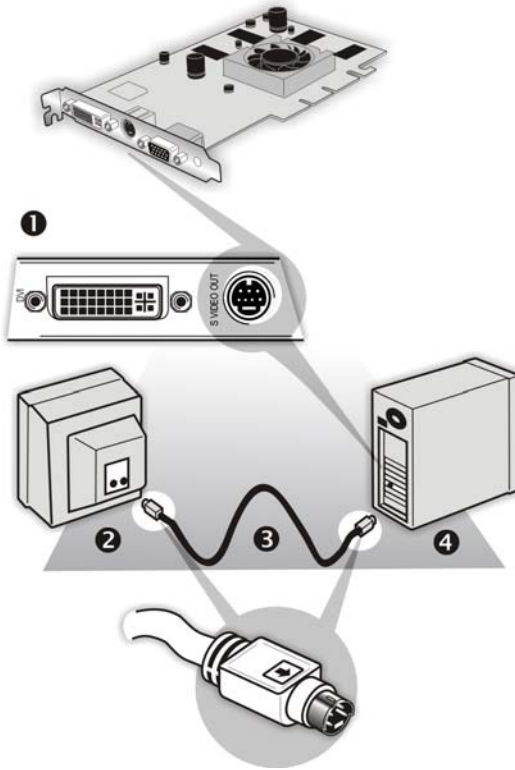

Connecting Your S-Video Out to a TV or VCR



-
- 1 S-Video Connection on graphics card
-
- 2 TV
-
- 3 S-Video Cable
-
- 4 Computer
-

Starting Windows® with TV Display Enabled

The TV screen may become scrambled during the initial Windows® logo display. This distortion is only a temporary effect, and your screen will be restored within a few seconds.

During start up, your RADEON™ X700 PCIe Series will go through a sequence of mode settings, during which your TV display will remain blank. This process takes only a few seconds and programs the TV display.

To enable or disable the TV display

- 1 Access the Windows® **Control Panel**. Double-click **Display**.
- 2 Click the **Settings** tab and then the **Advanced** button.
- 3 Click the **ATI Displays** tab. Click the **TV** button.
- 4 Click the enable button  or disable button  accordingly.
- 5 Click **OK** or **Apply** to save the changes.

Using and Adjusting TV Display Features

For information about how to adjust TV display features, right-click the **ATI taskbar icon**, point to **Help**, then point to **ATI Television Display**.

TV Display Hardware Restrictions

A TV cannot be left connected to the graphics card if two analog monitors are connected to your RADEON™ X700 PCIe Series card, even if the TV is off and not enabled in the software.

Similarly, an analog monitor connected to the DVI-I connector should not be left connected to your RADEON™ X700 PCIe Series card when TV Out is enabled. In both cases, your RADEON™ X700 PCIe Series will become overloaded, resulting in a dim image on all devices.

Using a Monitor vs. Using TV Display

Using your TV for your computer's display can be useful, however, the display on your monitor may change or looked squashed. This distortion occurs because the display adjusts to fit the dimensions of your TV. To correct the monitor's display, use the monitor's control buttons to adjust its display size and position.

Some single-frequency monitors may not work with TV display enabled. If you experience problems when TV display is enabled, disable TV display to restore your monitor's display.

Adjusting Monitor Display

The size of the display on your monitor may become smaller and not perfectly centered when you have TV display enabled. These effects are caused by the changes the graphics card is required to make in order to display your desktop properly on a TV.

Use the controls available on the **Adjustments** tab on the **Monitor Properties** page (accessible by clicking on the **Monitor** button on the ATI Displays tab) to adjust the display on your monitor only. Click the **TV** button to adjust the TV display only.

Viewing Text on a TV

A TV is designed primarily to show moving images. The large dot pitch of a TV will yield poor quality static images. The small text sizes commonly used for PC desktops can appear blurred or unclear on a TV. You can compensate for this degradation by using larger fonts.

Switching to a larger display font

- 1 Access the Display Properties dialog by right-clicking on the desktop or navigating through Windows® **Control Panel**.
- 2 Click the **Settings** tab, the **Advanced** button, and then the **General** tab.
- 3 In the **Display** section, select **Large (120 DPI)** from the **Font Size** (or **DPI Setting**) drop-down list.
- 4 Click **Apply**. If prompted, click **Yes** to restart your Computer.

Reducing Edge Distortion

When using a TV for your computer's display, you may see some edge distortion on the left and right side of your TV screen. This effect depends on your TV and the computer application you are running.

You can reduce edge distortion by increasing the TV display's horizontal size or contrast.

Increasing the horizontal size of a TV display

- 1 Access the Display Properties dialog by right-clicking on the desktop or navigating through Windows® **Control Panel**.
- 2 Click on the **Settings** tab and then the **Advanced** button.
- 3 Click on the **ATI Displays** tab.
- 4 Click on the **TV** button.

- 5 Click the **Adjustments** tab.
- 6 In the **Screen Size** section, click on the plus (+) button beside the horizontal arrowheads  to increase the horizontal size of the TV display.
- 7 Click **OK** or **Apply** to save the changes you have made.

You can also reduce edge distortion by increasing the TV's contrast.

Increasing the contrast of a TV display

- 1 Access the Display Properties dialog by right-clicking on the desktop or navigating through Windows® **Control Panel**.
- 2 Click on the **Settings** tab and then the **Advanced** button.
- 3 Click on the **ATI Displays** tab.
- 4 Click on the **TV** button.
- 5 Drag the **Contrast** slider to the right to increase the contrast.
- 6 Click **OK** or **Apply** to save the changes you have made.

Using TV Display Alone

If you plan to move your computer to a place where you are using TV display only, make sure that you have the TV display feature enabled prior to removing the monitor.

The maximum display resolution for TV is 1024x768. Choosing a resolution higher than this will cause the TV display to disappear if it is the only display device.

Using Games and Applications

Some older games and applications may program your RADEON™ X700 PCIe Series directly to run under a specific display mode. This may cause your TV display to turn off automatically or become scrambled (your PC monitor or portable LCD display will not be affected). Your TV display will be restored once you exit the game or if you restart your computer.

Connecting to HDTV

View computer output directly on your High Definition Television (HDTV) or other component input device. Provide a big-screen experience for your computer that is ideal for playing games, giving presentations, watching movies, and browsing the Internet.

HDTV uses YPbPr connectors to receive input. YPbPr stands for the following:

- Y = Green
- Pb = Blue
- Pr = Red

The HDTV Component Video Adapter can be used in place of the standard A/V Output cable to connect to an HDTV or other component input device, using component video cables.



You must have a monitor attached to your computer before installing the ATI HDTV. For proper operation of your ATI Component Video Adapter, ATI display drivers must be correctly installed.

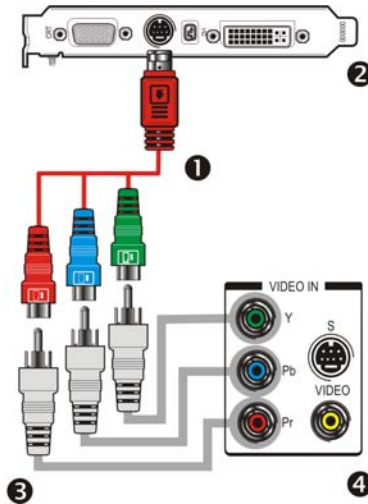

ATI HDTV Cable

- 1** ATI HDTV Video Output Cable

ATI HDTV Cable

- 2 Backplate of the ATI Graphics Card

- 3 Male RCA Patch Cables – available from consumer electronics dealer

- 4 Typical HDTV Video Input Connections

Note: Input and output cables lengths should not exceed 50 feet (15m).

Installing your ATI HDTV video cable

- 1 Turn on your component input device, and set it to YPbPr input.

Note: See your HDTV or component input device manual for configuration information specific to your device.

- 2 Turn on your computer.

Note: Your TV will not display anything until Windows starts. This can take several minutes.

Using Your ATI HDTV Video Cable

Use the HDTV Video Cable to watch DVD movies and play video games on your High Definition Television.

 Copy-protected DVDs restrict playback to 480i and 480p modes.

For maximum performance when you watch DVD movies or play computer games on your HDTV, you should find the mode and screen resolution that provide the best result on your TV, and use those settings exclusively.

To change HDTV display settings

- 1 Click the Windows **Start** button, point at **Settings**, and then click **Control Panel**.
- 2 Double-click the **Display** icon, click the **Settings** tab, and use the **Screen Area** slider to select the resolution you want.

Note: If the resolution you select is not related to a timing, the system will reduce the resolution to the closest supported timing.

- 3 Click the **Advanced** button, then click the **Displays** tab.
- 4 Click the **YPbPr** tab.
- 5 Click **OK**.
- 6 Click the **Advanced** button.
- 7 Click the **Adapter** tab, then click the **List All Modes** button.
- 8 Click **640 x 480**.
- 9 Then select either **640 x 480**.
 - 60Hz = Progressive.
 - 30Hz = Interlaced

Note: YPbPr is only available with the 30Hz or 60HZ settings.

Capturing Video

The RADEON™ X700 PCIe Series has the ability to capture video from your camcorder, VCR, or TV. Use your favorite video editing application to add effects, make changes, or stream your video on the Internet.

The audio and video output connectors on your TV, camcorder, or VCR will be similar those depicted in the illustration. Use Composite Video Out or S-Video Out. S-Video Out will provide better results.

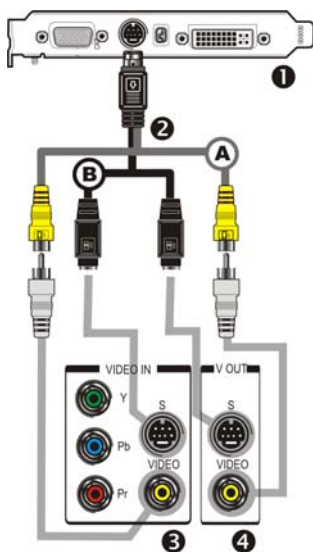

Connecting Your Video Device to Your RADEON™ X700 PCIe Series Card

A Composite In and Out Connectors. **Recommended connector** for best picture quality.

B S-Video In and Out Connectors.

1 ATI Graphics Card

2 Video In/Video Out Cable

3 Typical Video In of TV, VCR, or Camcorder connections

4 Typical Video Out of TV, VCR, or Camcorder connections

Connecting your media device for video capture

Use the Video In/Video Out Cable to connect to a TV, VCR, or Camcorder. Use the S-Video connectors.

To capture video to your computer

- 1 Connect the ATI Video In/Video Out cable to the Video In/Video Out connector on the ATI Graphics Adapter.

- 2 Connect the Video In of the ATI Video In\Video Out cable to the Video Out of your media device.

Note: S-Video and Composite extension cables are available from a consumer electronics dealer

- 3 Start your video capture software in record mode. For more information see the documentation that came with your video capture software.
- 4 Power on your TV or hit Play on your TV or VCR.

Note: To capture sound, you must connect the Line Out of your media device to the Line In of your sound card. Audio cables are available from a consumer electronics dealer.

Setting the Windows® Volume Control

For correct audio performance, your sound card's Line Input must be active.

To display the Line Input settings

- 1 **Right-click** the **Speaker** icon in the **Taskbar**, which usually in the lower-right corner of your screen.

If the volume icon is not in your Taskbar, do the following:

- Click **Start**, then click **Control Panel**.
- Double-click **Sounds and Audio Devices**.
- In the **Volume** tab, check **Place volume icon in the taskbar**.

- 2 Click **Open Volume Controls**.
- 3 If the Line-In volume slider is not visible, click **Options**, then click **Properties**.
- 4 Click the **Line-In** volume control checkbox, then click **OK**. If the **Mute** checkbox is checked, click it to cancel muting.

CHAPTER 5:

Troubleshooting

The following troubleshooting tips may help if you experience problems. ATI's documentation contains helpful installation/configuration tips and other valuable feature information. Please contact your dealer for more advanced troubleshooting information.

More troubleshooting information can be found on the ATI Website at ati.com/support/.

Uninstalling Old Graphics Card Software

To ensure successful installation of your RADEON™ X700 PCIe Series card, you must uninstall the graphic drivers for the existing graphics card before removing it from your computer.

To uninstall old graphics drivers

- 1 With your current graphics card still in your computer, close all open applications.
- 2 Click **Start > Settings > Control Panel**, then select **Add/Remove Programs**.
- 3 Select your current graphic drivers, then click **Add/Remove**:
 - The Wizard will help you remove your current display drivers.
 - Restart your system after the drivers have been removed.

i If the previously installed graphics card has any additional software installed, they may also need to be removed at this point. For example, DVD Player or Multimedia applications.

Windows® New Hardware Found

Windows may start the **Add New Hardware Wizard** to install the Standard VGA Driver.

To install and detect your new hardware

- 1 Click **Next** to allow Windows® to search for the Standard VGA or Standard PCI Graphics Adapter.
If prompted for the Windows® CD-ROM, insert it into your CD-ROM drive.
- 2 Type the following: **D:\<Operating System name>** for example **D:\WinXP**.
If D is not your CD-ROM drive, substitute D with the correct drive letter.
- 3 Click **OK**.
- 4 Click **Finish** to close the Wizard and then restart your system.

Installing the CATALYST™ Software Suite

ATI's CATALYST™ software suite provides you with all you need to get the most out of your ATI Graphics Accelerator card. The CATALYST™ software suite comprises four, distinct software elements:

- Driver.
- Multimedia Center.
- HydraVision (not included in the *Express* Install).
- Remote Wonder Software.

To ensure you install supported software, use the ATI Installation CD-ROM that shipped with your ATI Graphics Accelerator card.

To install the CATALYST™ Software Suite

- 1 Insert the ATI INSTALLATION CD-ROM into your CD-ROM drive.
If Windows® runs the CD-ROM automatically, proceed to step 6.
- 2 Click **Start**.
- 3 Select **Run**.
- 4 Type the following: **D:\ATISSETUP**
If D is not your CD-ROM drive, substitute D with the correct drive letter.
- 5 Click **OK**.
- 6 Click **Install** under Software Install.

- 7 Click **Next**.
- 8 Click **Yes** to the license agreement.
- 9 Click **ATI Easy Install** to begin the Installation Wizard.
- 10 Follow the Wizard's on-screen instructions to complete the installation.

Note: The Express installation option is recommended. If your ATI Graphics Accelerator card includes a multimedia component, the software for that component will automatically be installed, along with the ATI graphics driver. Not all software components are installed using the Express installation. Custom installation allows you to select individual software components for installation.

Solution Selector

General Problems

Problem	Possible Solution
Computer Does Not Boot-Up Properly	<ul style="list-style-type: none">• Verify that the installation instructions were properly followed.• Check that the card is properly installed in your system and connected to your monitor.• If you have problems during start-up, restart your computer in Safe Mode. While starting Windows® XP, press and hold F8 until you see the Windows® Advanced Options Menu. Use the arrow keys to select Safe Mode, and press Enter. Check the system configuration utility of your operating system for the interrupt assignments.• Contact Dell Technical Support if the problem persists.

General Problems	
Problem	Possible Solution
No Display	<ul style="list-style-type: none"> Check that the card is seated properly in its expansion slot. Ensure that the monitor cable is securely fastened to the card. Make sure that the monitor and computer are plugged in and receiving power. If necessary, disable any built-in graphics capabilities on your mother board. For more information, consult your computer's manual or manufacturer. (Note: some manufacturers do not allow the built-in graphics to be disabled or to become the secondary display.) Make sure that you selected the appropriate monitor when you installed your enhanced driver.
Screen Defects Appear	<ul style="list-style-type: none"> Check if your monitor supports the resolution, horizontal (kHz) and vertical (Hz) refresh rates as required by the graphics card. Check your current resolution, refresh rate, and color depth settings in the Settings and Monitor tabs in your Display Properties dialog. <p>Warning! Ensure that both video card and monitor support resolution and refresh rates you select. Incompatible resolution/refresh rate selection may result in monitor damage. Refer to your monitor's documentation for recommended resolutions and refresh rates.</p>
Off-Center Screen Image, Odd Colors or No Picture	<ul style="list-style-type: none"> Try adjusting the brightness, sharpness, contrast, and color balance controls of your monitor. Try adjusting the centering and positioning controls of your monitor to position the picture on the screen. Note: The Screen Position settings in Display Properties > Advanced > Displays > Adjustments tune the position of the picture on the screen via the video signal. Set the monitor's RGB inputs (and sync switches, if this option is available) to 75 Ohms, with the sync set to external. Digital Flat Panel (DFP) monitor users: refer to your monitor's documentation for the appropriate cable and connector to plug into the DVI-I connector on the graphics card.

General Problems

Problem	Possible Solution
Operating System Warns that Video Card Isn't Properly Configured	<ul style="list-style-type: none"> • Check the driver installation and make sure that all software is correctly loaded corresponding to your operating system and applications. • Re-install the ATI drivers for your RADEON™ X700 PCIe Series card.

HDTV/HDTV Adapter Troubleshooting

Problem	Possible Solution
The colors on my TV display are incorrect	<ul style="list-style-type: none"> • Ensure that the connections between the Component Video Adapter and your HDTV are correct (Y=Green, Pb=Blue, Pr=Red).
There is no display on my TV	<ul style="list-style-type: none"> • Your TV will not display anything until Windows starts; this may take several minutes. • Set your TV to YPbPr input. • Ensure that the HDTV Component Video Adapter is properly connected, then restart your computer.
DVDs will not play in 720p or 1080i modes	<ul style="list-style-type: none"> • Copy-protected DVDs restrict playback to 480i and 480p modes.
I can't see the entire display	<ul style="list-style-type: none"> • If your component input device supports it, try 720p mode.
The display appears tilted	<ul style="list-style-type: none"> • Consult your HDTV user's manual.
My CRT display is green	<ul style="list-style-type: none"> • Your system is in component output mode. Restart your computer with the CRT monitor connected.

Compliance Information

FCC Compliance Information

This RADEON™ product complies with FCC Rules part 15. Operation is subject to the following two conditions

- This device may not cause harmful interference, and
- This device must accept any interference received, including interference that may cause undesired operation.

This equipment has been tested and found to comply with the limits for a Class B digital device, pursuant to Part 15 of the FCC Rules. These limits are designed to provide reasonable protection against harmful interference in a residential installation. This equipment generates, uses and can radiate radio frequency energy and, if not installed and used in accordance with manufacturer's instructions, may cause harmful interference to radio communications. However, there is no guarantee that interference will not occur in a particular installation. If this equipment does cause harmful interference to radio or television reception, which can be determined by turning the equipment off and on, the user is encouraged to try to correct the interference by one or more of the following measures:

- Re-orient or relocate the receiving antenna.
- Increase the separation between the equipment and receiver.
- Connect the equipment to an outlet on a circuit different from that to which the receiver is connected.
- Consult the dealer or an experienced radio/TV technician for help.

The use of shielded cables for connection of the monitor to the graphics card is required to ensure compliance with FCC regulations. Changes or modifications to this unit not expressly approved by the party responsible for compliance could void the user's authority to operate this equipment.

Industry Canada Compliance Statement

ICES-003 This Class B digital apparatus complies with Canadian ICES-003.

Cet appareil numérique de la Classe B est conforme à la norme NMB-003 du Canada.

For further compliance information:

ATI Research Inc.
4 Mount Royal Ave.
Marlborough, MA
01752-1976
USA
508-303-3900

CE Compliance Information

EMC Directive 89/336/EEC and Amendments 92/31/EEC and 93/68/EEC, for Class B Digital Device.
 EN 55022:1998/CISPR 22:1997, - Class B - Limits and Methods of Measurement of Radio Disturbance Characteristics of Information Technology Equipment.
 EN55024:1998/CISPR 22:1997, - Information Technology Equipment - Immunity Characteristics - Limits and Methods of Measurement.

Low Voltage Directive for TV-Tuner-Equipped products
 73/23/EEC - The Low Voltage Directive.
 EN 60950: 1992+A1+A2+A3+A4 - Safety of Information Technology Equipment.

L'Information de conformité de la CE

Directive EMC 89/336/CEE et amendement 92/31/CEE et 93/68/EEC, dispositif numérique de Classe B.
 EN 55022:1998/CISPR 22:1997, - Classe B - Limites et méthodes de mesure des caractéristiques d'interférences radiophoniques, Matériel des technologies de l'information.
 EN 55024:1998/CISPR 24:1997, Limites et méthodes de mesure des caractéristiques d'immunité, Matériel des technologies de l'information Equipement de Technologie de l'Information - Caractéristiques d'Immunité - Limites et méthodes de mesure.

Directive de Basse Tension pour produits contenant tuner de télévision
 73/23/CEE - Directive basse tension.
 EN 60950 : 1992+A1+A2+A3+A4 - Sécurité du matériel des technologies de l'information.

CE-Konformitätserklärung

EMC Richtlinie 89/336/EEC und Änderungen 92/31/EEC und 93/68/EEC, Digitales Gerät der Klasse B.
 EN 55022:1998/CISPR 22:1997, - Klasse B - Grenzwerte und Meßverfahren für Funkstörungen von Einrichtungen der Informationstechnik.
 EN 55024:1998/CISPR 24:1997, Einrichtungen der Informationstechnik, Störfestigkeitseigenschaften, Grenzwerte und Prüfverfahren.

Niederspannung Richtlinie für Produkte Enthalten Fernsehen tuner
 73/23/EEC - Niederspannungsrichtlinie.
 EN 60950: 1992+A1+A2+A3+A4 - Sicherheit für Einrichtungen der Informationstechnik.

Index

Numerics

3D 11

- custom settings* 25
- performance* 25
- profiles* 25
- quality* 25

3D applications

- settings* 14

A

adjusting

- overlays* 21

application profiles

- creating* 24

ATI Overlay tab 21

ATI taskbar applications

- disabling* 17, 18
- enabling* 17, 18

B

brightness 13, 14

- color settings* 11
- video overlay* 21

C

capture video 40, 41

card specification information 17

Catalyst

- version number* 17

CATALYST Software

- installing* 44

Clone Mode

- overlay settings* 22
- settings* 22

clone mode

- primary display* 22
- secondary displays* 22

color

- hotkeys* 14
- profiles* 13

color contrast, contrast

- color* 13

color preview

- color settings* 14

color profile, profile

- color* 11
- color settings
 - brightness* 11
 - color preview* 14
 - contrast* 11
 - desktop* 13
 - gamma* 11
 - profiles* 13
- Compliance information
 - Low Voltage Directive for TV-tuner-equipped products* 50
- contrast 13, 14
 - color settings* 11
 - TV display* 36
 - video overlay* 21
- Copy-protection
 - DVDs, DVDs*
 - Copy-protection 47
- custom settings
 - 3D* 25
- D**
- desktop
 - color settings* 13
- display corruption
 - DVI* 18
 - high resolution* 18
- Displaying PC output on TV 40
- displays
 - Hotkey* 9
 - primary* 8
 - scheme* 9
 - secondary* 8
- dot pitch 36
- driver information 17
- DVI operational mode 18
- DXT texture formats 29
- E**
- external connectors 1
- F**
- full screen 3D, 3D
 - full screen* 11
- G**
- games
 - TV display* 37
- gaming performance, performance
 - gaming* 7
- gamma 13, 14

- color settings* 11
 - video overlay* 21
- gamma correction 13
- graphics card
 - resetting through VPU Recover* 31

H

- HDTV 38, 39
 - troubleshooting* 47
- HDTV adapter
 - troubleshooting* 47
- HDTV Component Video Adapter 38
- High Definition Television 38
- horizontal size
 - TV display* 36
- hue
 - video overlay* 21

I

- Input and output adapters
 - displaying PC output on TV and recording on videotape* 40
- installing
 - CATALYST Software 44

M

- multiple displays
 - rotate* 20

O

- old graphics drivers
 - uninstall* 43
- Options tab 17
- overlay adjustments 21
- overlay settings
 - Clone Mode* 22

P

- performance
 - 3D* 25
- primary display 8
 - clone mode* 22
- profiles
 - 3D* 25
 - color* 13
 - color settings* 13

Q

- quality
 - 3D* 25

R

- Recording PC output on videotape 40
- resetting graphics card 31

rotate

multiple displays 20

single display 20

Rotation HotKeys 20

S

safety instructions iii

saturation

video overlay 21

secondary display 8

secondary displays

clone mode 22

settings

3D applications 14

Clone Mode 22

single display

rotate 20

system requirements 1

T

tab

Overlay 21

Theater Mode 22

Triple Buffering 30

troubleshooting

general problems 45

HDTV 47

HDTV adapter 47

TV

displaying PC output on 40

TV display 33, 36, 37

contrast 36

games 37

hardware restrictions 35

horizontal size 36

TV Out 33, 35

U

uninstall

old graphics drivers 43

Uninstalling old graphics card software 43

V

VGA 22

video capture 40

Video overlay

definition 21

video overlay 21

brightness 21

contrast 21

gamma 21

hue 21

saturation 21

Volume control 42

VPU Recover 31

W

Windows volume control 42

Y

YPbPr 40, 47

YPbPr connector 38

Z

Z-Buffer depth

explicitly setting 30