

## **Chapter 2**

### **HARDWARE INSTALLATION**

#### **2.1 Central Processing Unit: CPU**

The mainboard operates with **Intel® Pentium® II/III/ Celeron™ processor**. The mainboard uses a CPU Slot called Slot 1 for easy CPU installation and a jumper switch (SW1) to set the proper speed for the CPU. The CPU should always have a Heat Sink and a cooling fan attached to prevent overheating.



\***Heat Sink Support Pin (HSSPIN)** - Plastic pins inserted through the HSSBASE to secure it to the mainboard (2 required per Assembly).

\***Heat Sink Support Top Bar (HSSTOP)** - Plastic bar that clips onto the HSSBASE through the fins on the ATX heatsink.

\*\***Heat Sink w/ fan** - Heat Sink that can be attached to the **Pentium® II/III processor** with metal clip.

**Note:** \* Provided by MSI mainboard.

\*\* Provided by Special request.

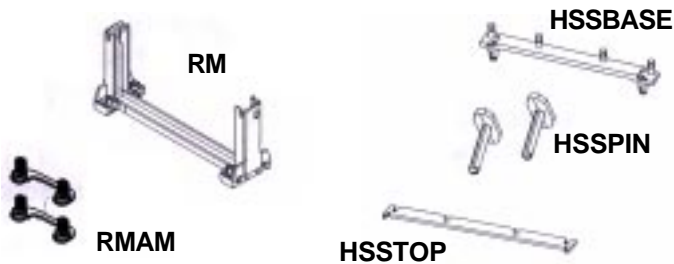

**Step 1:** Insert the Retention Mechanism Attach Mount at the bottom of the mainboard.

**Step 2:** Install the Retention Mechanism.

Look for the key on Slot 1, and match it with the Notch Key on the Retention Mechanism for proper direction. Then, attach the Retention Mechanism to the Retention Mechanism Attach Mount. Use a Screwdriver to secure the Retention Mechanism.

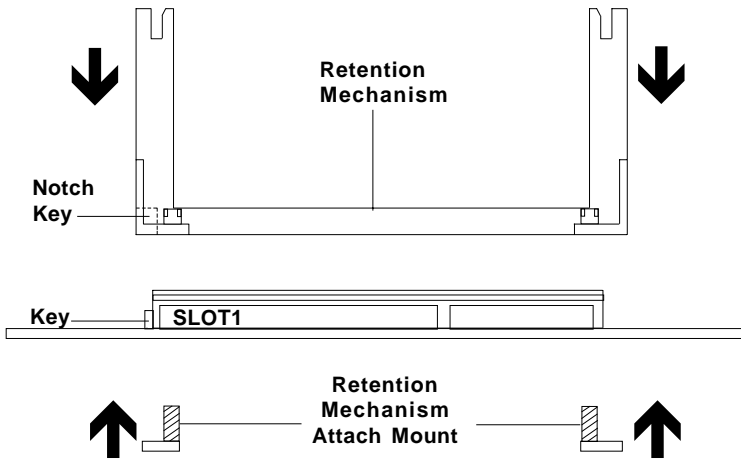

**Step 3:** Install the Heat Sink Support Base.

Look for the Two holes across Slot 1, and match it with the Two legs of the Heat Sink Support Base for the proper direction. Take note that one hole/leg is bigger than the other. The Four top pins of the Heat Sink Support Base should also be oriented towards Slot 1.

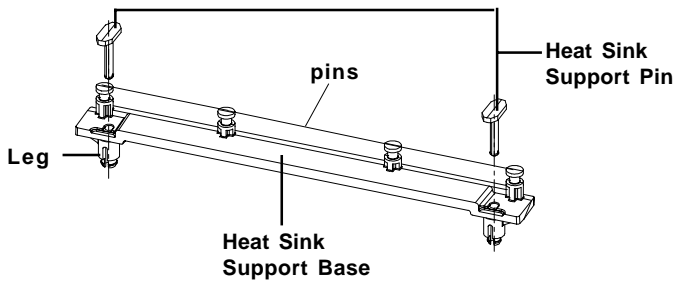

Push the Heat Sink Support Base onto the mainboard, until you hear a click sound. Check for a perfect fit.

**Step 4:** Install the Heat Sink Support Pin.

Push the Heat Sink Support Pins onto the two holes of the Heat Sink Support Base. Check for a perfect fit. These pins are used to secure the Heat Sink Support Base.

**Step 5:** Install the Heat Sink with Fan to the Processor.

Push down the metal clips, so that they are in line with the back of the Heat Sink. Be careful, so as not to detach the metal clips from the Heat Sink.

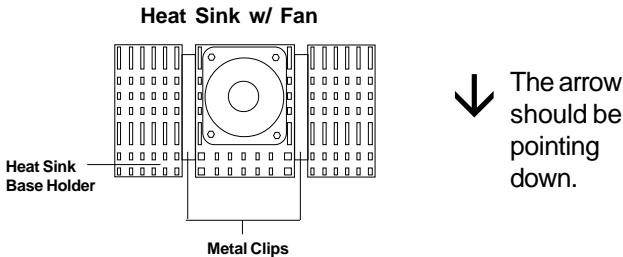

In case the metal clips are detached from the Heat Sink, re-attach them. Look for the arrow on the metal clip. This arrow should be pointing down and aligned with the Heat Sink Support Base Holder.

Attach the Heat Sink to the processor.

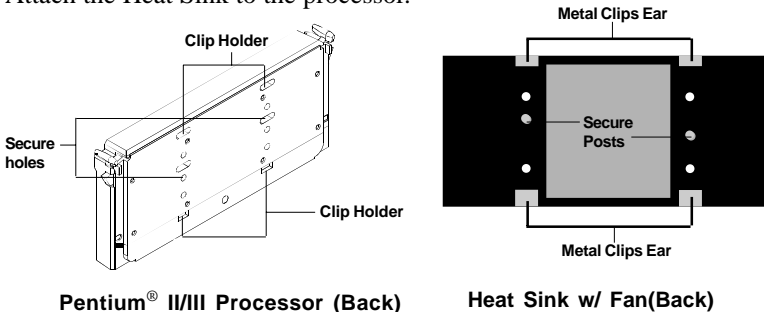

- Look at the back of the Heat Sink and take note of the 2 secure posts. Insert these 2 Secure posts to the 2 secure holes on the back of the processor.
- Align the ears of the metal clips with the clip holders on the back of the processor. Use a screw driver to push the metal clips onto the clip holders. Check for a perfect fit.

**Step 6:** Install the Processor.

Unlock the Processor by pushing in the Processor Locks.



Insert the Processor like inserting a PCI or an ISA card.

**Step 7:** Lock the Processor Locks.

Secure the CPU by pulling the Processor Locks out.



**Step 8:** Install the Heat Sink Support Top Bar.

Push the Heat Sink Support Top Bar to the Heat Sink Support Base, until you hear a “click” sound. Check for a perfect fit.



**Heatsink  
Support Top  
Bar**

The installation is now complete.



## B. Boxed Pentium® II Processor Installation Procedures

The Boxed Pentium® II Processor has a built-in Fan and Heat Sink. It also has a Heat Sink Support. So if you're going to use a Boxed Pentium™ II Processor, all you need is the Retention Mechanism.

**Step 1:** Insert the Retention Mechanism Attach Mount at the bottom of the mainboard.

**Step 2:** Install the Retention Mechanism.

Look for the key on Slot 1, and match it with the Notch Key on the Retention Mechanism for proper direction. Then, attach the Retention Mechanism to the Retention Mechanism Attach Mount. Use a Screwdriver to secure the Retention Mechanism.

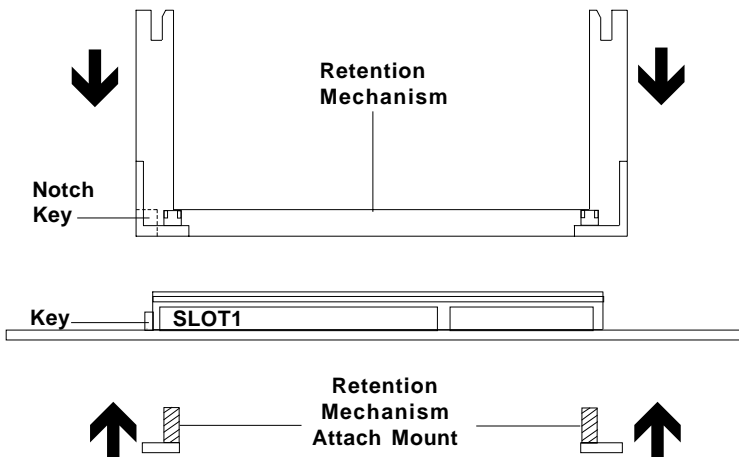

**Step 3:** Install the Heat Sink Support Base.

Look for the 2 holes across Slot 1, and match it with the 2 Heat Sink Support Base. Take note that one hole/base is bigger than the other.

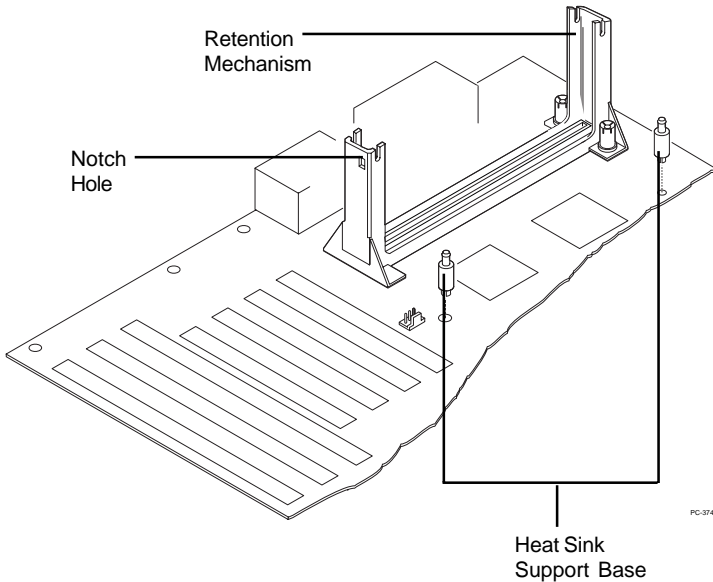

Push the Heat Sink Support Base onto the mainboard, until you hear a click sound. Check for a perfect fit.

**Step 4:** Install the Heat Sink Support.

Attach the 2 Heat Sink Supports to the sides of the Processor. These Heat Sink Supports will fit in any direction, so be sure that the Heat Sink Support Locks are oriented outwards for the proper direction.

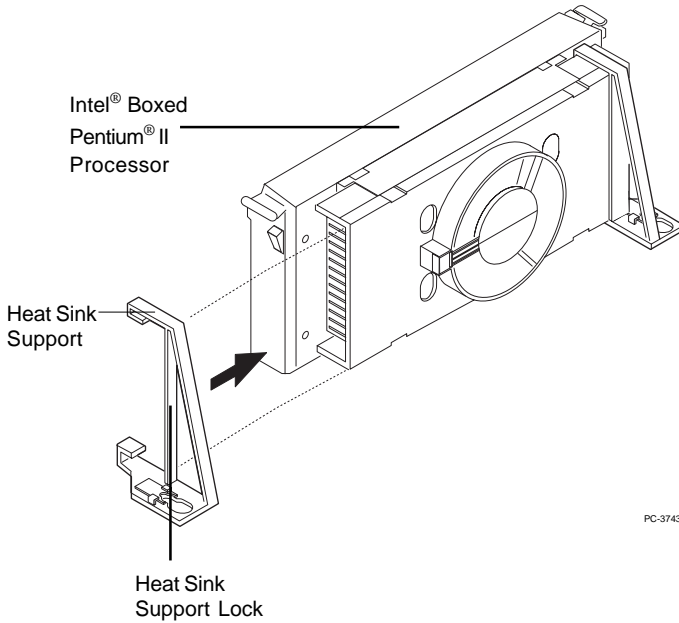

**Step 5:** Unlock the Processor Locks and Heat Sink Support Locks.

Push in the Processor Locks. Open the Heat Sink Support Locks.

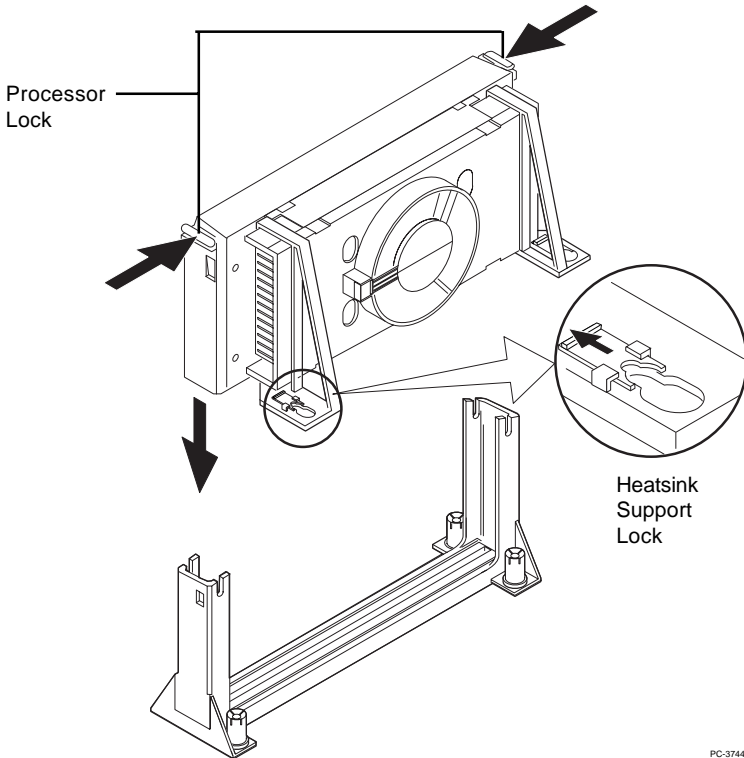

**Step 6:** Insert the Processor like inserting a PCI or an ISA card.

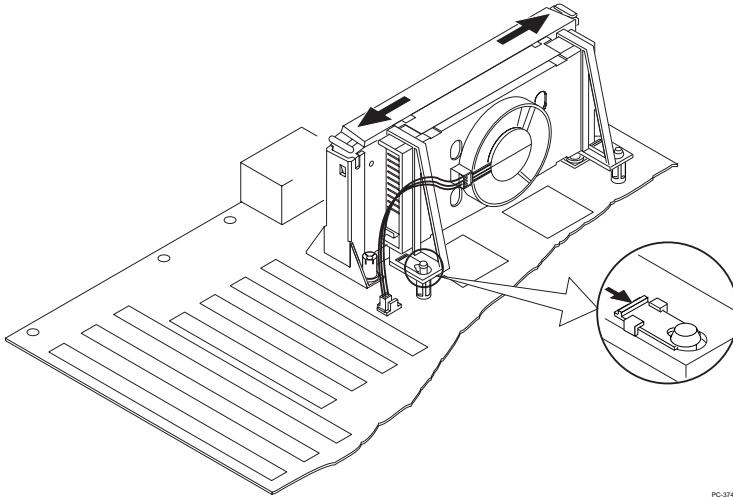

PC-3746

**Step 7: Lock the Processor Locks and Heat Sink Support Locks**

Secure the CPU by pushing out the Processor Locks. Close the Heat Sink Support Locks.

The installation is now complete.

**C. OEM Celeron™ Processor Installation Procedures**

**Step 1:** Insert the Retention Mechanism Attach Mount at the bottom of the mainboard.

**Step 2:** Install the Retention Mechanism.

Look for the key on Slot 1, and match it with the Notch Key on the Retention Mechanism for proper direction. Then, attach the Retention Mechanism to the Retention Mechanism Attach Mount. Use a Screwdriver to secure the Retention Mechanism.

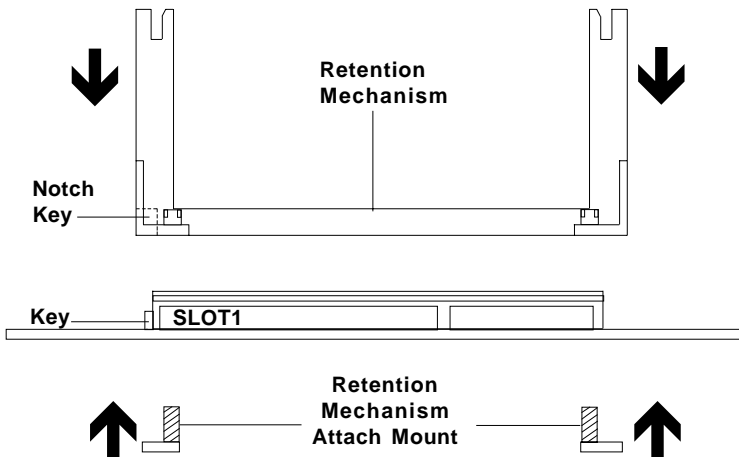

**Step 3:** Install the MSI Heat Sink (optional) to the Processor.

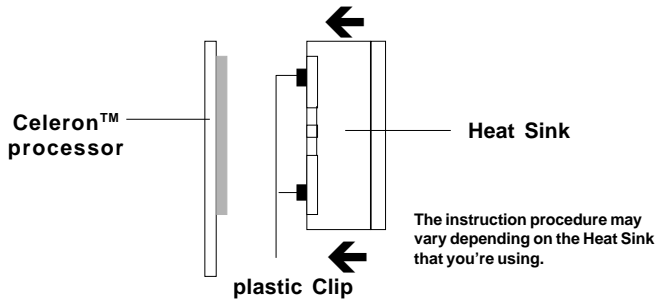

Push down the plastic clips, so that they are in line with the hole on the processor. Check for perfect fit.

**Step 4:** Install the Processor.

Insert the Processor like inserting a PCI or an ISA card.

**Step 5:** Lock the Processor

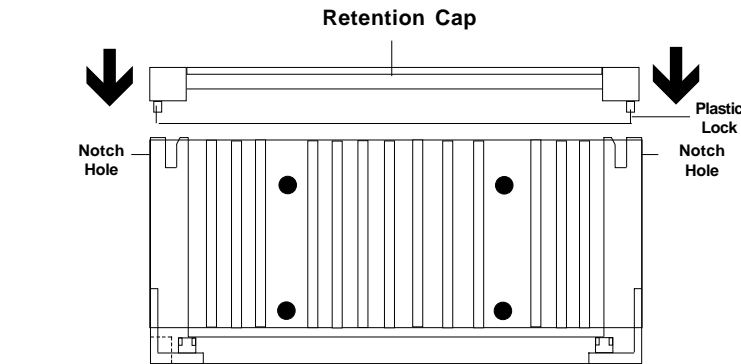

Lock the processor by putting the Retention Cap provided. Take note of the two plastic lock at the side of the Retention Cap. This two plastic lock should be aligned properly into the Retention Mechanism notch hole.

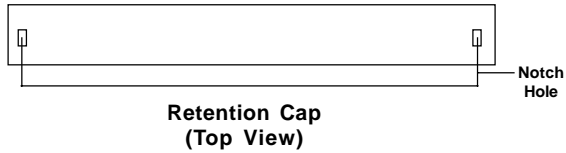
**Procedure for detaching the Retention Cap:**

To remove the Retention Cap, you need a Screw Driver (0.3 cm) tip.

- Insert the screw driver into the retention cap notch hole.
- Push the retention cap plastic lock inward.
- Pull the retention cap upward.



**2.1-2 CPU Core Speed Derivation Procedure**

1. The DIP Switch SW1 (1, 2, 3, and 4) is used to set the Core/Bus (Fraction) ratio of the CPU. The actual core speed of the CPU is the Host Clock Frequency multiplied by the Core/Bus ratio. For example:

$$\begin{aligned}
 \text{If } & \text{CPU Clock} & = & 66\text{MHz}/100\text{MHz} \\
 & \text{Core/Bus ratio} & = & 4 \\
 \text{then } & \text{CPU core speed} & = & \text{Host Clock} \times \text{Core/Bus ratio} \\
 & & = & 66\text{MHz} \times 4/100\text{MHz} \times 4 \\
 & & = & 266\text{MHz}/400\text{MHz}
 \end{aligned}$$

SW1				CPU
1	2	3	4	Core/Bus Ratio
ON	OFF	ON	ON	2.5
ON	ON	OFF	ON	3
ON	OFF	OFF	ON	3.5
ON	ON	ON	OFF	4
ON	OFF	ON	OFF	4.5
ON	ON	OFF	OFF	5
ON	OFF	OFF	OFF	5.5
OFF	ON	ON	ON	6
OFF	OFF	ON	ON	6.5
OFF	ON	OFF	ON	7
OFF	OFF	OFF	ON	7.5
OFF	ON	ON	OFF	8

ON - Short OFF - Open



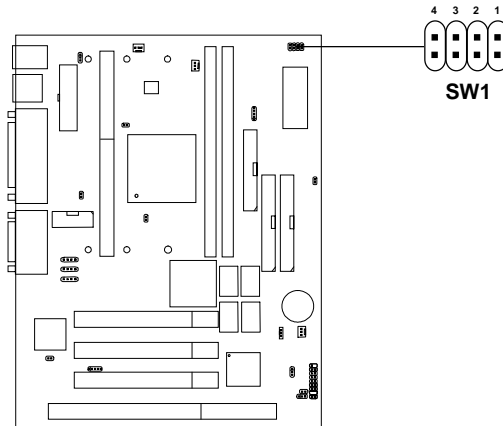

**Note:** The CPU Bus Frequency is set at 66MHz or 100MHz by CPU default.

### 2.1-3 CPU Speed Setting: SW1

To adjust the speed of the CPU, you must know the specification of your CPU (*always ask the vendor for CPU specification*). The mainboard can auto-detect between 66 or 100MHz CPU Bus Frequency.





**a. 66MHz CPU Bus Frequency**

CPU Type	SW1
233MHz	
266MHz	
300MHz	
333MHz	

**Table 2.1 233 ~ 333MHz Intel® Pentium® II/Celeron™ processor**

**b. 100MHz CPU Bus Frequency**

CPU Type	SW1
350MHz	
400MHz	
450MHz	

**Table 2.2 350 ~ 450MHz Intel® Pentium® II processor**

### 2.1-4 Fan Power Connectors: CPUFAN/PSEFAN/SYSFAN

These connectors support system cooling fan with +12V. It supports three pin head connector. When connecting the wire to the connector, always take note that the red wire is the positive and should be connected to the +12V, the black wire is Ground and should be connected to GND. If your mainboard has System Hardware Monitor chipset on-board, you must use a specially designed fan with speed sensor to take advantage of this function.

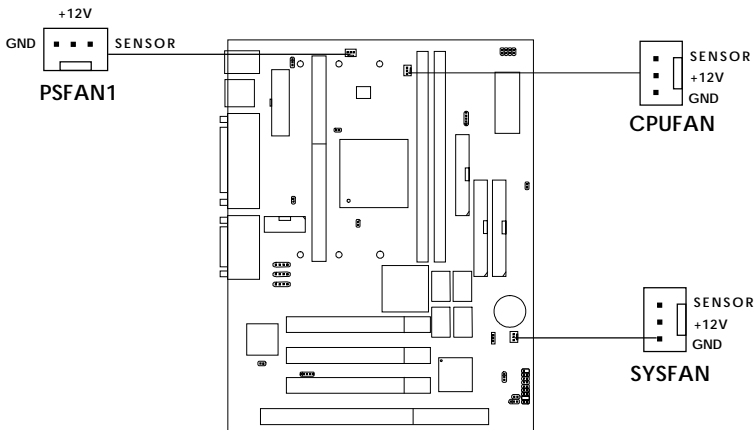

**PSFAN** : Power Supply Fan  
**CPUFAN** : Processor Fan  
**SYSFAN** : System(Chassis) Fan

For fans with fan speed sensor, every rotation of the fan will send out 2 pulses. System Hardware Monitor will count and report the fan rotation speed.

**Note:** 1. Always consult vendor for proper CPU cooling fan.

## 2.2 Clear CMOS Jumper: JBAT1

A battery must be used to retain the mainboard configuration in CMOS RAM. Short 1-2 pins of JBAT1 to store the CMOS data.

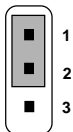
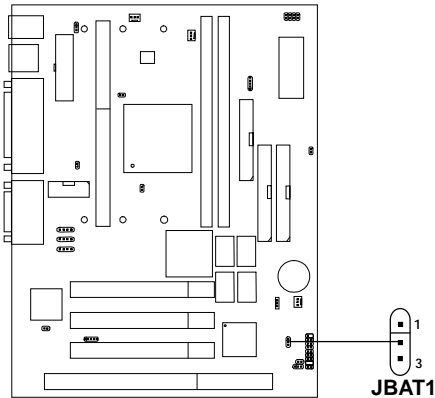

**Keep Data**

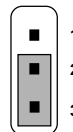

**Clear Data**

**Note:** You can clear CMOS by shorting 2-3 pin, while the system is off. Then, return to 1-2 pin position. Avoid clearing the CMOS while the system is on, it will damage the mainboard. Always unplug the power cord from the wall socket.

---

## 2.3 Memory Installation

### 2.3-1 Memory Bank Configuration

The mainboard supports a maximum memory size of 256MB (8M x 8) or 512MB (16M x 4) registered DIMM for SDRAM: It provides two 168-pin **unbuffered** DIMMs (Double In-Line Memory Module) sockets. It supports 8 MB to 256 Mbytes DIMM memory module.

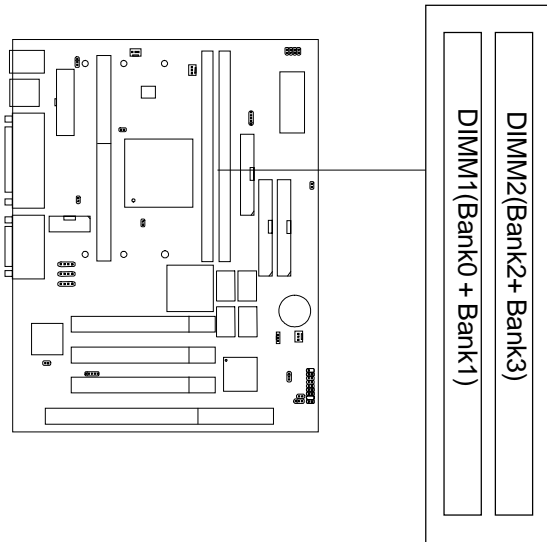

There are two kinds of DIMM specification supported by this mainboard: PC100 and PC66. If you use 66MHz CPU Bus Frequency, these two DIMM Specs. is supported. If you use 100 MHz CPU Bus Frequency, only PC100 DIMM Specs. is supported.

### 2.3-2 Memory Installation Procedures

#### A. How to install a DIMM Module

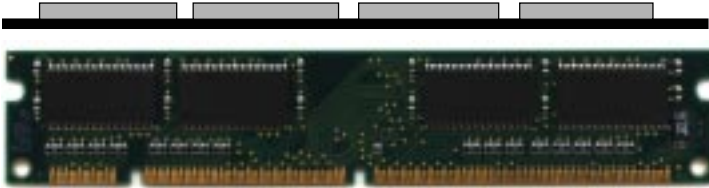

**Single Sided DIMM**

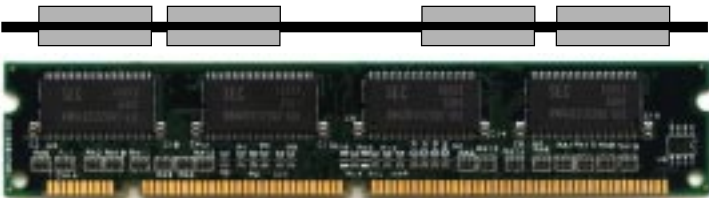

**Double Sided DIMM**

1. The DIMM slot has a two Notch Key “VOLT and DRAM”, so the DIMM memory module can only fit in one direction.
2. Insert the DIMM memory module vertically into the DIMM slot. Then push it in.

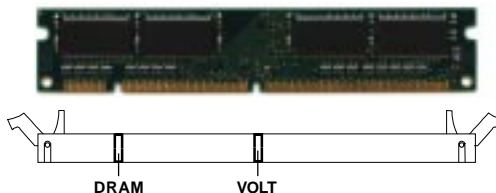

3. The plastic clip at the side of the DIMM slot will automatically close..

**2.3-3 Memory Population Rules**

1. Supports only SDRAM DIMM.
2. To operate properly, at least one 168-pin DIMM module must be installed.
3. This mainboard supports Table Free memory, so memory can be installed on DIMM1 or DIMM 2 in any order.
4. Supports 3.3 volt DIMM.
5. The DRAM addressing and the size supported by the mainboard is shown below:

**Table 2.3-1 SDRAM Memory Addressing**

DRAM Tech.	DRAM Density & Width	DRAM Addressing	Address Size		MB/DIMM	
			Row	Column	Single no. Side(S) pcs.	Double no. Side(D) pcs.
16M	1Mx16	ASYM	11	8	8MBx4	16MBx8
	2Mx8	ASYM	11	9	16MBx8	32MBx16
	4Mx4	ASYM	11	10	32MB	64MB
64M	2Mx32	ASYM	11	9	32MBx2	64MBx4
	2Mx32	ASYM	12	8	16MBx2	32MBx4
	4Mx16	ASYM	11	10	32MB	64MB
	4Mx16	ASYM	13	8	32MB	64MB
	8Mx8	ASYM	13	9	64MB	128MB
	16Mx4	ASYM	13	10	128MB	256MB
	2Mx32	ASYM	12	8	16MB	32MB
64M	4Mx16	ASYM	13	8	32MB	64MB
	8Mx8	ASYM	13	9	64MB	128MB
	16Mx4	ASYM	13	10	128MB	256MB



## 2.4 Case Connector: JFP1

The Power Switch, Reset Switch, Power LED, Speaker, Keylock and HDD LED are all connected to the JFP1 connector block.

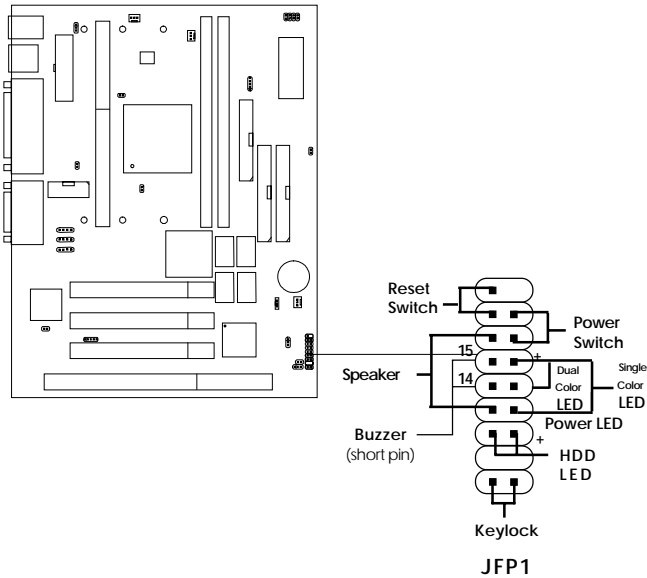

### **2.4-1 Power Switch**

Connect to a 2-pin push button switch. This switch had the same feature with JRMS1.

### **2.4-2 Reset Switch**

Reset switch is used to reboot the system rather than turning the power ON/OFF. Avoid rebooting while the HDD LED is lit. You can connect the Reset switch from the system case to this pin.

### **2.4-3 Power LED**

The Power LED is lit while the system power is on. Connect the Power LED from the system case to this pin. There are two types of LED that you can use: 3-pin single color LED or 2-pin dual color LED(ACPI request).

- a. 3 pin single color LED connect to pin 4, 5, & 6. This LED will lit when the system is on.
- b. 2 pin dual color LED connect to pin 5 & 6.

**GREEN**Color: Indicate the system is full on mode.

**ORANGE**Color: Indicate the system is in suspend mode.

### **2.4-4 Speaker**

Speaker from the system case is connected to this pin.

If on-board Buzzer is available:

Short pin 14-15: On-board Buzzer Enabled.

Open pin 14-15: On-board Buzzer Disabled.

### **2.4-5 HDD LED**

HDD LED shows the activity of a hard disk drive. Avoid turning the power off while the HDD led is lit. You can connect the HDD LED from the system case to this pin.

### **2.4-6 Keylock**

Keylock allows you to disable the keyboard for security purposes. You can connect the keylock to this pin.

## 2.5 Floppy Disk Connector: FDD

The mainboard also provides a standard floppy disk connector FDC that supports 360K, 720K, 1.2M, 1.44M and 2.88M floppy disk types. This connector supports the provided floppy drive ribbon cables.

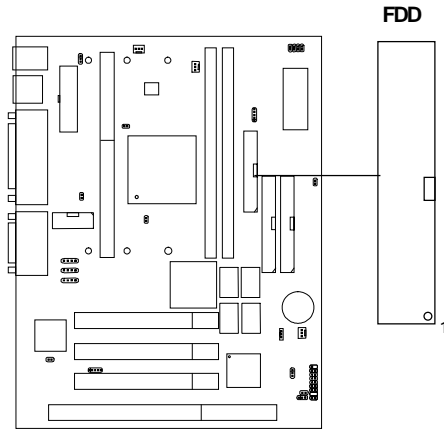

## 2.6 Hard Disk Connectors: IDE1 & IDE2

The mainboard has a 32-bit Enhanced PCI IDE Controller that provides PIO mode 0~4, Bus Master, and Ultra DMA/33 function. It has two HDD connectors IDE1 (primary) and IDE2 (secondary). You can connect up to four hard disk drives, CD-ROM, 120MB Floppy (reserved for future BIOS) and other devices to IDE1 and IDE2. These connectors support the provided IDE hard disk cable.

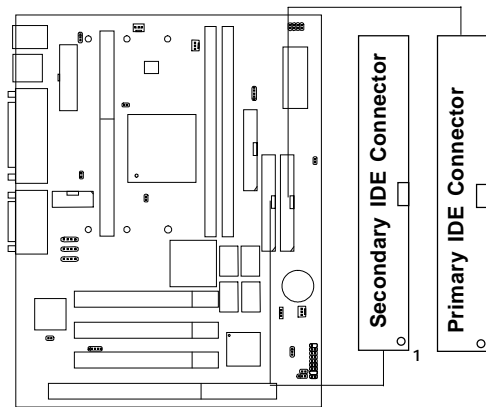

### IDE1(Primary IDE Connector)

The first hard drive should always be connected to IDE1. IDE1 can connect a Master and a Slave drive. You must configure second hard drive to Slave mode by setting the jumper accordingly.

### IDE2(Secondary IDE Connector)

IDE2 can also connect a Master and a Slave drive.

## 2.7 Power Supply

### 2.7-1 ATX 20-pin Power Connector: JPWR1

This connector supports the power button on-board. Using the ATX power supply, functions such as Modem Ring Wake-Up and Soft Power Off are supported by this mainboard. This power connector supports instant power on function which means that system will boot up instantly when the power connector is inserted on the board.

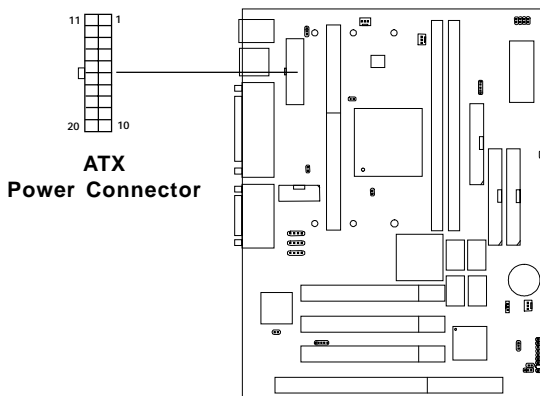

#### PIN DEFINITION

PIN	SIGNAL	PIN	SIGNAL
1	3.3V	11	3.3V
2	3.3V	12	-12V
3	GND	13	GND
4	5V	14	PS_ON
5	GND	15	GND
6	5V	16	GND
7	GND	17	GND
8	PW_OK	18	-5V
9	5V_SB	19	5V
10	12V	20	5V

**Warning:** Since the mainboard has the instant power on function, make sure that all components are installed properly before inserting the power connector to ensure that no damage will be done.

### 2.7-2 Remote Power On/Off Switch: JRMS1

Connect to a 2-pin push button switch. During OFF state, press once and the system turns on. **During ON stage, push once and the system goes to sleep mode: pushing it more than 4 seconds will change its status from ON to OFF.** If you want to change the setup, you could go to the BIOS Power Management Setup. This is only used for ATX type power supply.

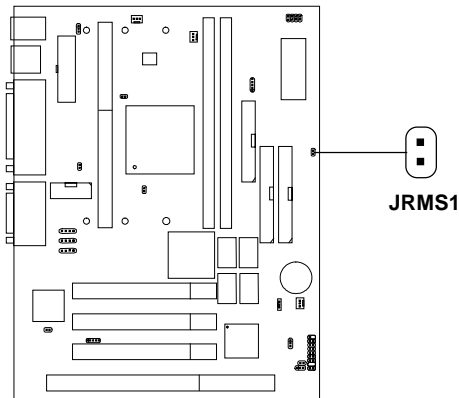

## 2.8 IrDA Infrared Module Connector: IR

The mainboard provides one 5-pin infrared (IR) connector for IR modules. This connector is for optional wireless transmitting and receiving infrared module. You must configure the setting through the BIOS setup to use the IR function. FIR and Consumer IR are reserved functions.

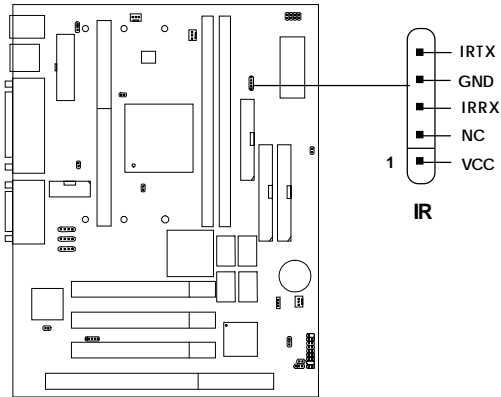

**2.9 Serial Port Connectors: COM 1 and COM 2**

The mainboard has a 9-pin male DIN connector for serial port COM 1. This port is a 16550A high speed communication port that send/receive 16 bytes FIFOs. You can attach a mouse or a modem cable directly into this connector.

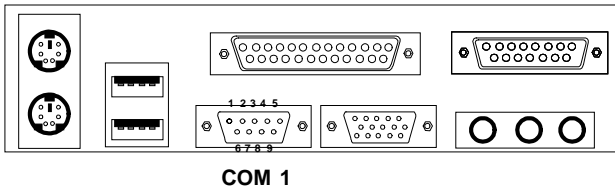

**Serial Port (9-pin Male)**

**PIN DEFINITION**

PIN	SIGNAL
1	<b>DCD</b> (Data Carry Detect)
2	<b>SIN</b> (Serial In or Receive Data)
3	<b>SOUT</b> (Serial Out or Transmit Data)
4	<b>DTR</b> (Data Terminal Ready)
5	<b>GND</b>
6	<b>DSR</b> (Data Set Ready)
7	<b>RTS</b> (Request To Send)
8	<b>CTS</b> (Clear To Send)
9	<b>RI</b> (Ring Indicate)

**Note:** There’s another serial port connector (COM 2), which is located on the mainboard. Connect a serial port 9-pin male port into this connector.



**2.10 Parallel Port Connector: LPT**

The mainboard provides a 25 pin female centronic connector for LPT. A parallel port is a standard printer port that also supports Enhanced Parallel Port(EPP) and Extended capabilities Parallel Port(ECP). See connector and pin definition below:

**Parallel Port (25-pin Female)**

**LPT**

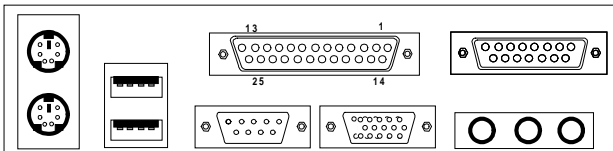

**PIN DEFINITION**

<b>PIN</b>	<b>SIGNAL</b>	<b>PIN</b>	<b>SIGNAL</b>
1	STROBE	14	AUTO FEED#
2	DATA0	15	ERR#
3	DATA1	16	INIT#
4	DATA2	17	SLIN#
5	DATA3	18	GND
6	DATA4	19	GND
7	DATA5	20	GND
8	DATA6	21	GND
9	DATA7	22	GND
10	ACK#	23	GND
11	BUSY	24	GND
12	PE	25	GND
13	SELECT		

## 2.11 Mouse Connector: JKBSM1

The mainboard provides a standard PS/2<sup>®</sup> mouse mini DIN connector for attaching a PS/2<sup>®</sup> mouse. You can plug a PS/2<sup>®</sup> mouse directly into this connector. The connector location and pin definition are shown below:

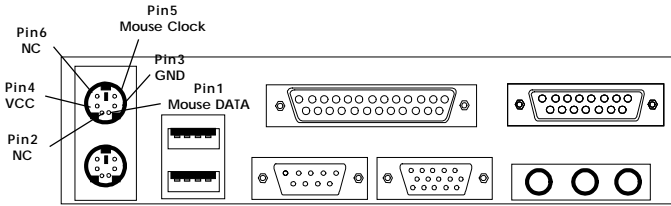

**PS/2 Mouse (6-pin Female)**

## 2.12 Keyboard Connector: JKBSM1

The mainboard provides a standard PS/2<sup>®</sup> keyboard mini DIN connector for attaching a keyboard. You can plug a keyboard cable directly to this connector.

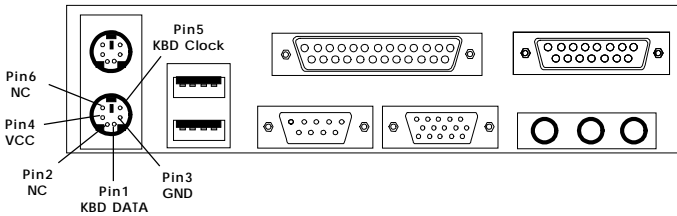

**PS/2 Keyboard (6-pin Female)**

### 2.13 Joystick/Midi Connectors

You can connect joystick or game pads to this connector.

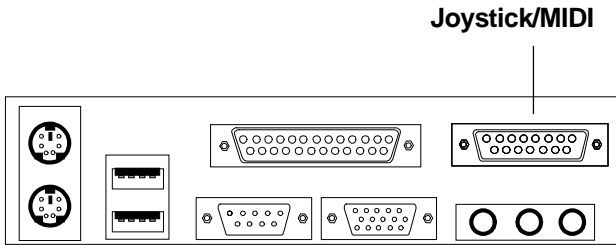

### 2.14 Audio Port Connectors

**Line Out** is a connector for Speakers or Headphones. **Line In** is used for external CD player, Tape layer, or other audio devices. **Mic** is a connector for the microphones.

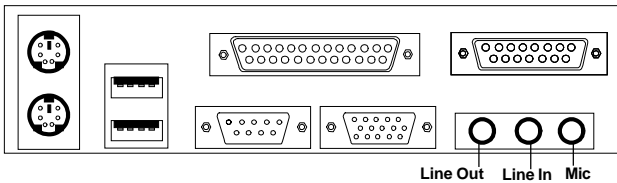

### 1/8" Stereo Audio Connectors

**2.15 USB Connectors**

The mainboard provides a **UHCI(Universal Host Controller Interface) Universal Serial Bus root** for attaching USB devices like: keyboard, mouse and other USB devices. You can plug the USB device directly to this connector.

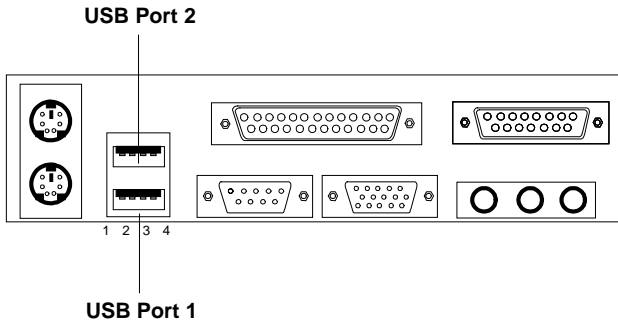

<b>PIN</b>	<b>SIGNAL</b>
1	VCC
2	-Data0
3	GND
4	+Data0

**2.16 VGA DB 15 Pin Connector**

The mainboard provides a DB 15-pin connector to connect to a VGA monitor.

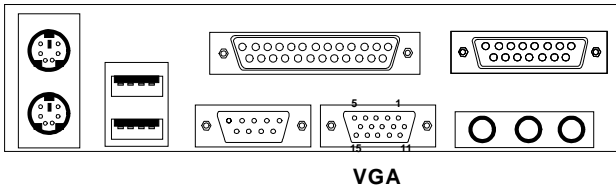



<b>Analog Video Display Connector(DB15-S)</b>	
<b>Pin</b>	<b>Signal Description</b>
1	Red
2	Green
3	Blue
4	Not used
5	Ground
6	Ground
7	Ground
8	Ground
9	Not used
10	Ground
11	Not used
12	SDA
13	Horizontal Sync
14	Vertical Sync
15	SCL

## **2.17 Onboard VGA Disable/Enable Jumper: JP2**

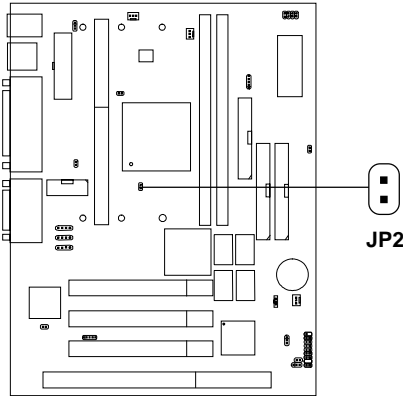
This jumper is used to Enable/Disable the onboard VGA feature.



<b>JVGA1</b>	<b>Function</b>
	<b>Enable Onboard VGA</b>
	<b>Disable Onboard VGA</b>

## 2.18 Power Saving Switch Connector: JGS1

Attach a power saving switch to **JGS1**. When the switch is pressed, the system immediately goes into suspend mode. Press any key and the system wakes up.

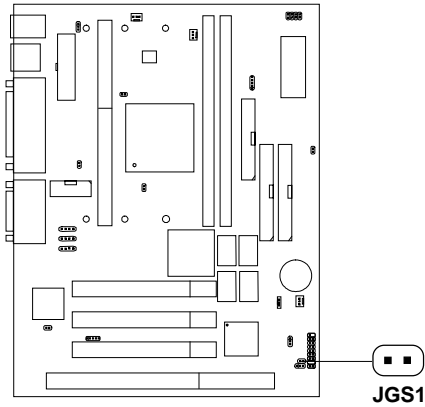

**2.19 Power Saving LED Connector: JGL1**

JGL1 can be connected with two-color LED. There are two type of LED that you can use: 3-pin LED or 2-pin LED(ACPI request). LED will lit while the system is in suspend mode.

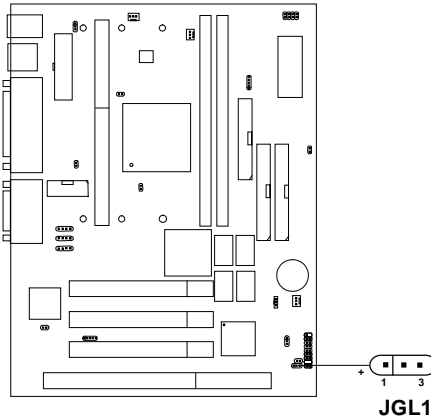

3-pin LED	2-pin LED
<p>1-2 Single Color 1-3 Blink</p>	<p>1-2 Dual Color</p>



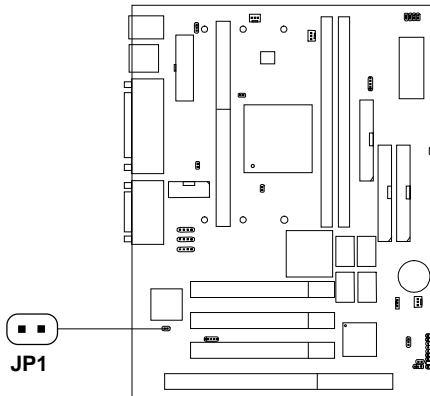

## 2.20 Power On Mode Jumper: JP1

The mainboard supports three kinds of system boot up: the Boot-Up by switch, Immediate Boot-Up, and Last State. With the **Boot-Up by Switch**, the system will boot up only when the power on switch is pressed. For **Immediate Boot-Up**, the system will boot up instantly when the power connector is connected into the system; this function must be set in the BIOS Power Management. For **Last State**, this will record the last status the system was in: either System on or Shut down. The next time you boot up, the system will remember the last status. This function must be set at the BIOS Power Management Setup.



**Table 2.20: Power On Mode Feature**

JP1	Feature
	Select Boot-Up by Switch
	Select Immediate Boot-Up/ Select Last State

**Note:** Short **JP1**, when using Boot-Up by Switch feature. Open **JP1**, to enable Immediate Boot-Up or Last State.

**2.21 Wake-Up on LAN Connector: JWOL**

The JWOL connector is for use with LAN add-on cards that supports Wake Up on LAN function. To use this function you need to set the “Resume By Ring” to enable at the BIOS Power Management Setup.

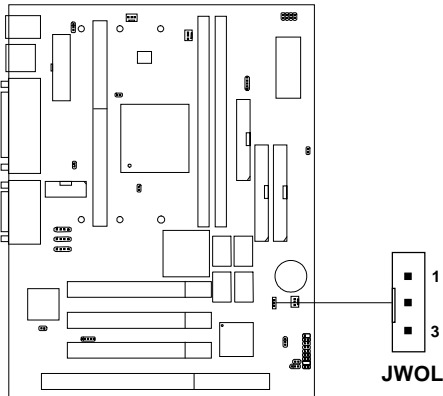

PIN	SIGNAL
1	5VSB
2	GND
3	MP_WAKEUP

**Note:** LAN wake-up signal is active “high”.

**Note:** To be able to use this function, you need a power supply that provide enough power for this feature.  
(750 ma power supply with 5V Stand-by)

**2.22 Modem Wake Up Connector: JMDM1**

The JMDM1 connector is for used with Modem add-on card that supports the Modem Wake Up function. To use this function, you need to set the “Resume By Ring” to enable at the BIOS Power Management Setup.

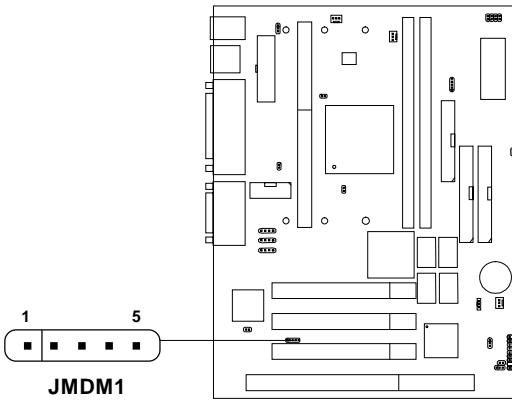

PIN	SIGNAL
1	NC
2	GND
3	MDM_WAKEUP
4	NC
5	5VSB

**Note:** Modem wake-up signal is active “low”.

**Note:** To be able to use this function, you need a power supply that provide enough power for this feature.  
(750 ma power supply with 5V Stand-by)

## 2.23 Modem-In: J6

The connector is for Modem with internal voice connector.

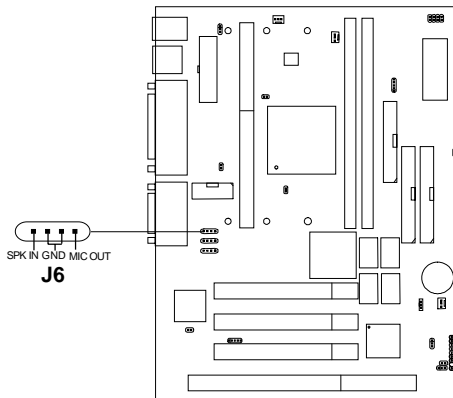

SPK\_IN is connected to the Modem Speaker Out connector.

MIC\_OUT is connected to the Modem Microphone In connector.

## 2.24 AUX Line In Connector: J5

This connector is used for DVD Add on Card with Line In connector.

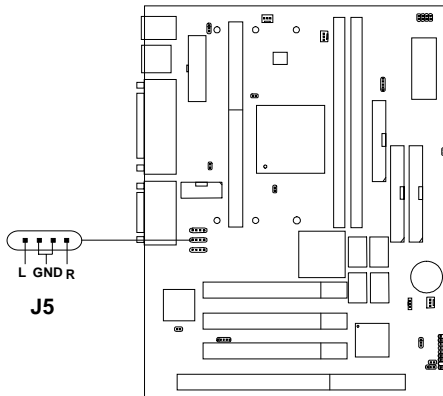

## 2.25 CD-In Modem Connector: J8

This connector is for Modem with internal voice connector.

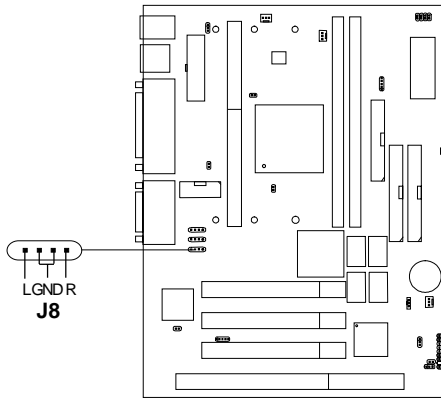

## 2.26 CPU Temperature Sensor: JSOR1 (optional)

This is used to check the CPU temperature. The J1 is a sensor that is placed near the processor heatsink. This will monitor the CPU temperature.

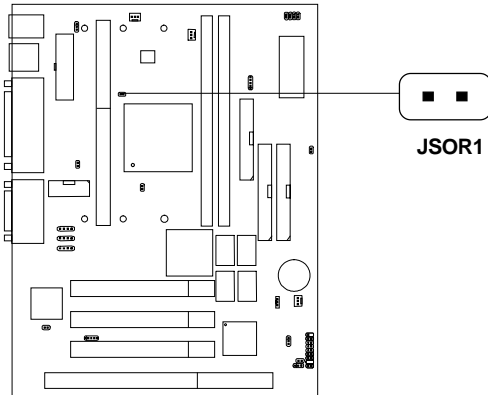

## **2.27 Chassis Intrusion Switch Connector: J3**

This connector is connected to 2-pin connector chassis switch. If the Chassis is open, the switch will be short. The system will record this status. To clear the warning, you must enter the BIOS setting and clear the status.

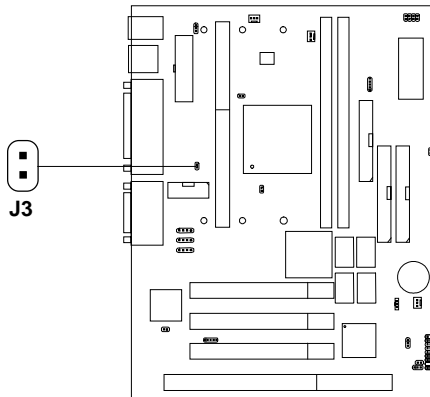



## 2.28 Keyboard Power: JVSBI (reserved)

The JVSBI jumper is for setting keyboard power. This function is provided by keyboard and PS/2 mouse Wake-up function.

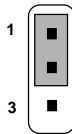
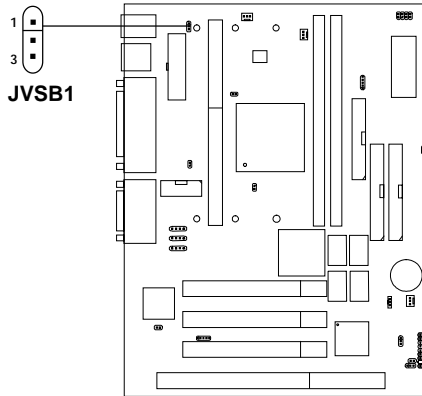

5V Standby  
Enable keyboard  
power on function

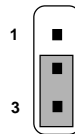

5V (default)  
Disable keyboard  
power on function

**Note:** To be able to use this function, you need a power supply that provide enough power for this feature.  
(750 ma power supply with 5V Stand-by)